

REV
SH
DWG NO 4185

REVISIONS			
REV	DESCRIPTION	DATE	APPROVED

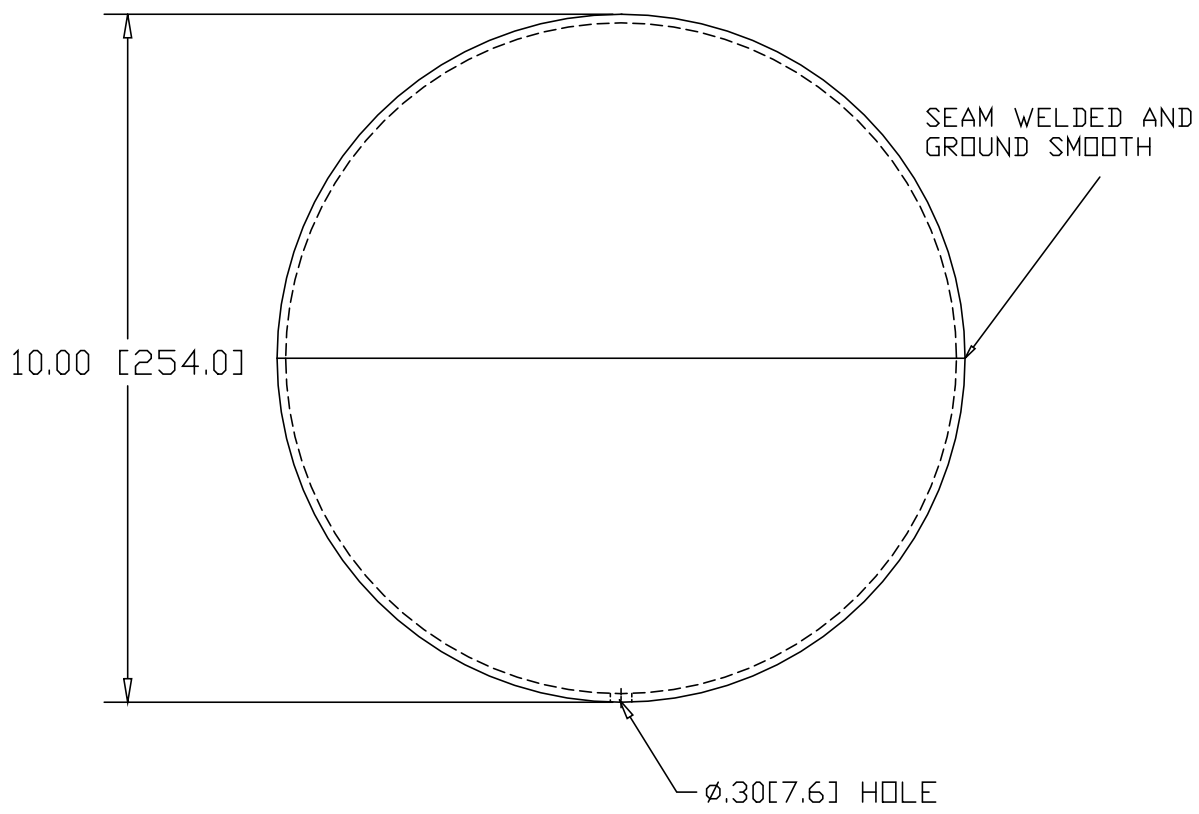

INCHES [MILLIMETERS]

ALTERNATE MATERIAL	PART NUMBER
.125 (3003) ALUMINUM SHEET ASTM B209	4187
11 GA. (.1200) 304 STAINLESS STEEL A240	4188
.125 (260) BRASS	4189
.125 (655) SILICON BRONZE	SB4185

PART NAME		10.00" DIAMETER HOLLOW BALL		
MATERIAL		11 GA. (.1196) HRP&D STEEL SHEET ASTM A569		
DATE	1/4/00		THE WAGNER COMPANIES R & B WAGNER, INC. AND J. G. BRAUN CO.	
DRAWN BY	RJF			
FINISH	MILL			
SIZE	WEIGHT	PART NUMBER	REV	
A	10.00 LBS	4185		