

REV  
SH  
4431  
DWG NO

REVISIONS			
REV	DESCRIPTION	DATE	APPROVED

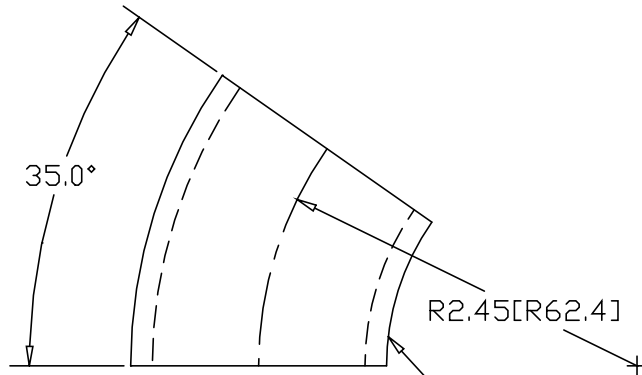

NOTE: UNWELDED SEAM  
ALONG INSIDE RADIUS  
(STEEL ELLS ONLY)

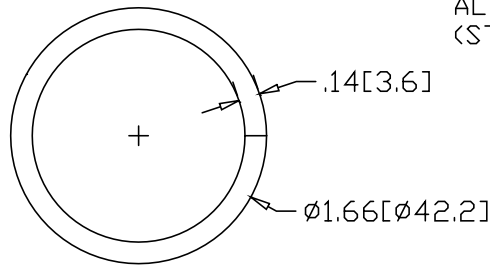

INCHES [MILLIMETERS]

ALTERNATE MATERIAL	PART NUMBER
1-1/4" SCH 40 (6063) ALUMINUM PIPE	4441
1-1/4" SCH 40 (304) STAINLESS STEEL PIPE	4651

PART NAME				1-1/4" PIPE SIZE 35° ELL X 1-5/8" I.R.	
MATERIAL				10 GA. HRP&D STEEL ASTM A569	
DATE	8/18/95			R & B WAGNER, INC.	
DRAWN BY	RJF				
FINISH	MILL	SIZE	A	WEIGHT	.29 LBS
			PART NUMBER	4431	
			REV		