

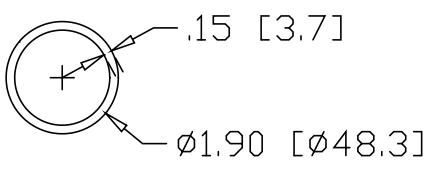

REV  
SH  
8306  
DWG NO

REVISIONS			
REV	DESCRIPTION	DATE	APPROVED

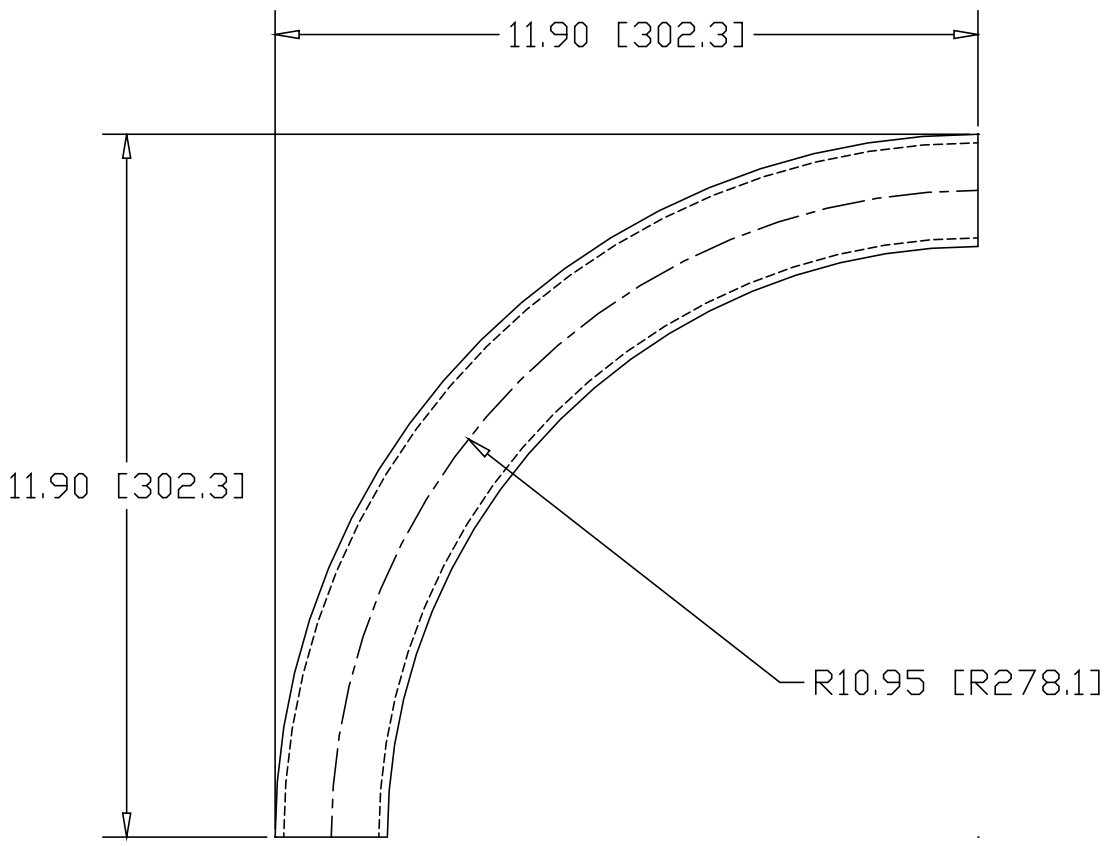

INCHES [MILLIMETERS]

ALTERNATE MATERIAL	PART NUMBER
1-1/2" SCH 40 (6063) ALUMINUM PIPE	8320
1-1/2" SCH 40 (304) STAINLESS STEEL PIPE	8334

PART NAME		1-1/2" PIPE SIZE 90° ELL X 10" I.R.					
MATERIAL		1-1/2" SCH 40 A53 STEEL PIPE					
DATE	8/7/01	 <b>R &amp; B WAGNER, INC.</b>					
DRAWN BY	JAH						
FINISH	MILL						
SIZE	A	WEIGHT	3.90 LBS	PART NUMBER	8306	REV	