

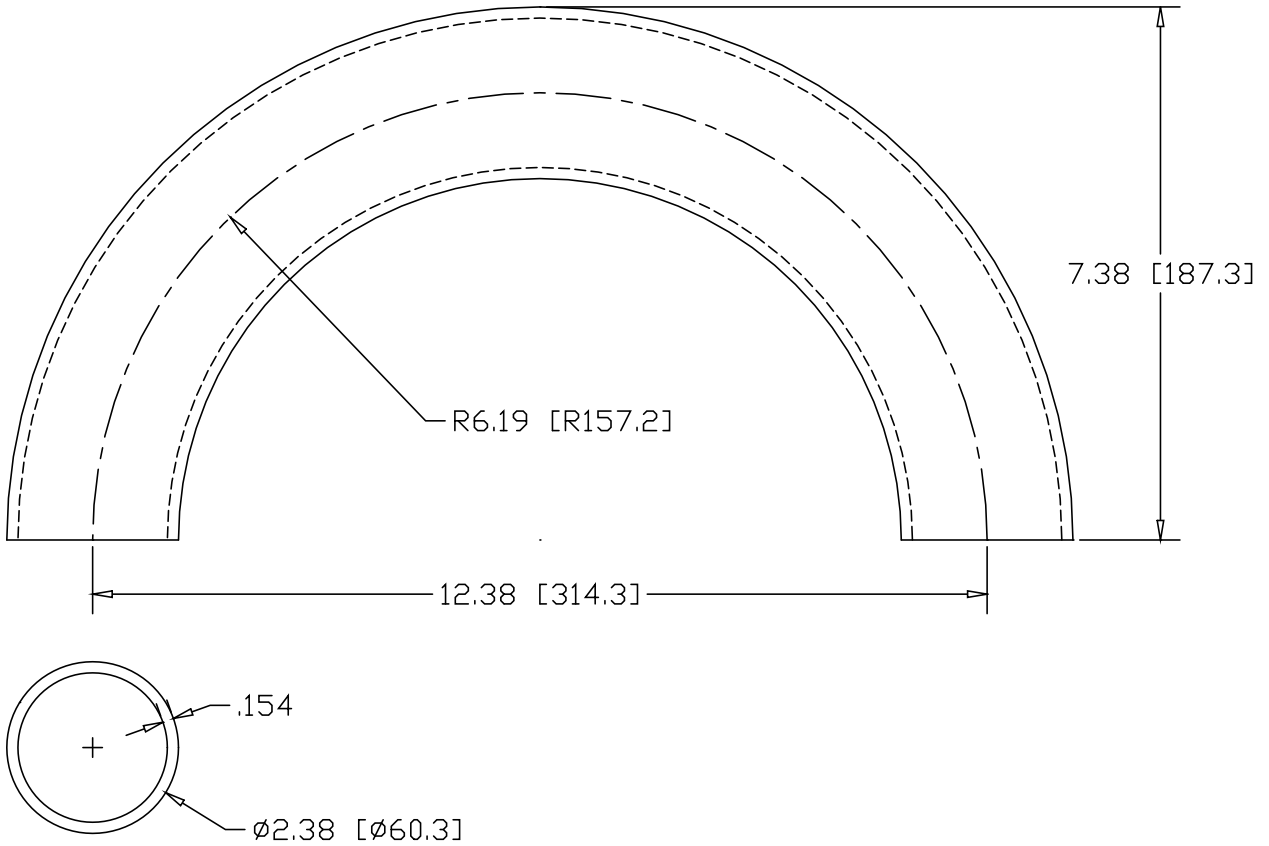

REV
SH
7193
DWG NO

REVISIONS			
REV	DESCRIPTION	DATE	APPROVED



INCHES [MILLIMETERS]

PART NAME		2" PIPE SIZE 180° ELL X 5" I.R.					
MATERIAL		2" SCH 40 A53 STEEL PIPE					
DATE	7/02/01	 THE WAGNER COMPANIES R & B WAGNER, INC. AND J. G. BRAUN CO.					
DRAWN BY	JAH						
FINISH	MILL						
SIZE	A	WEIGHT	5.92 LBS	PART NUMBER	7193	REV	