

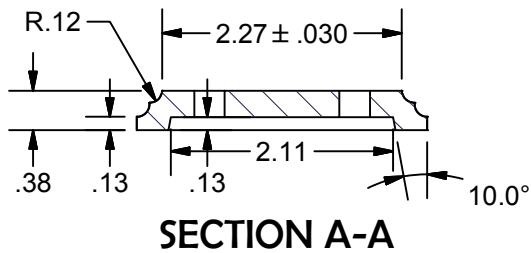

REVISION HISTORY

REV	DESCRIPTION	DATE	APPROVED
1	SADDLE THICKNESS .21 WAS .18	09/09/13	KTURDO
2	INCREASED HOLE TOLERANCES	11/18/13	KTURDO
3	REDRAWN	06/22/15	RJF

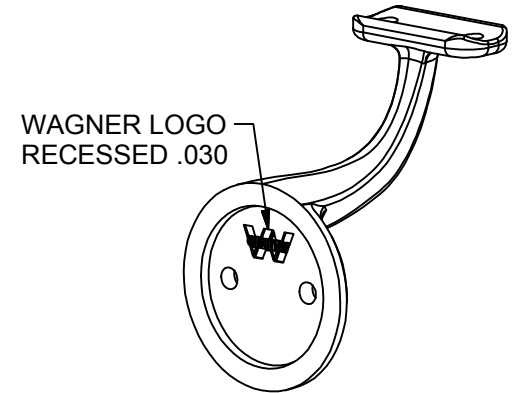
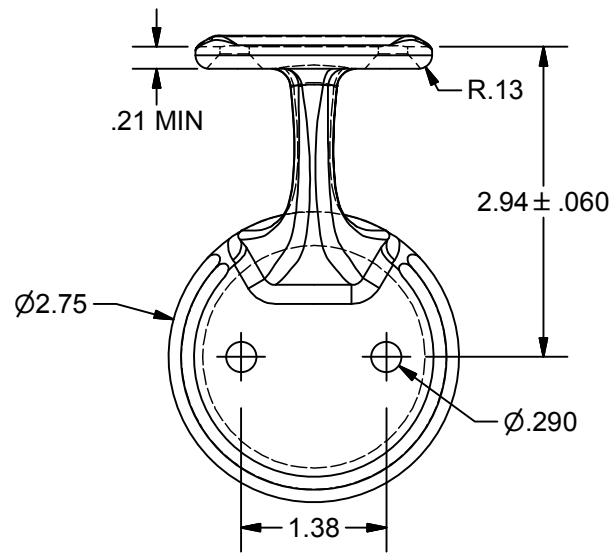
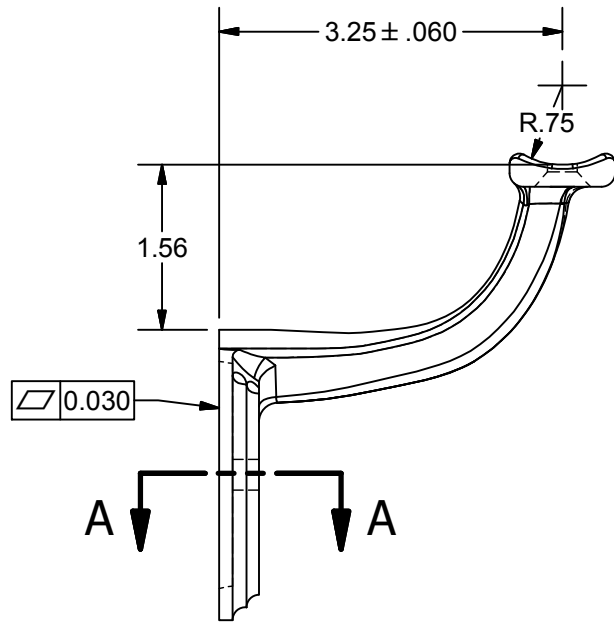
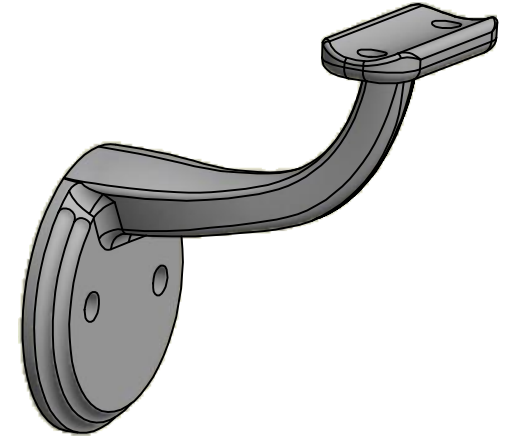
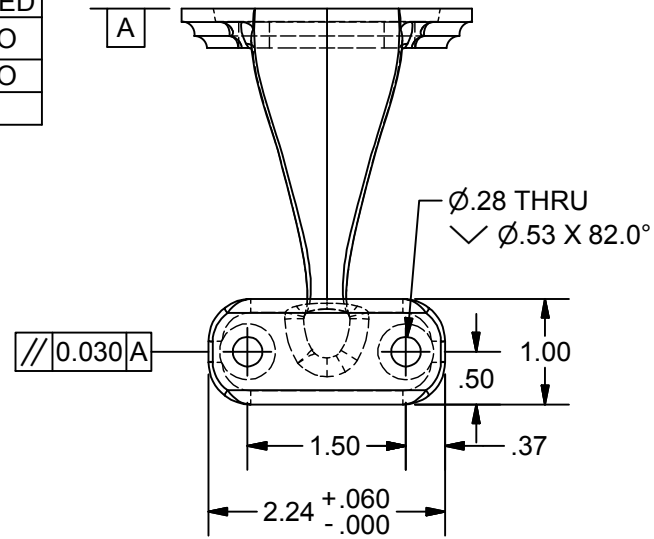

NAME		3.25" TRADITIONAL CAST HANDRAIL BRACKET					
MATERIAL		304 STAINLESS STEEL ASTM A276-304					
DATE	5/25/2010	COLLABORATIVE METAL WORKS					
DRAWN	RJF	 WAGNER ™					
FINISH	#4 SATIN						
SIZE	A	WEIGHT	.915 lbs	PART NUMBER	1816-2	REV	3