

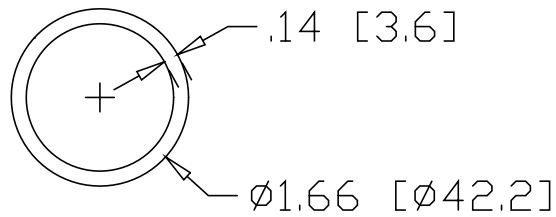

REV  
SH  
7463  
DWG NO

| REVISIONS |             |      |          |
|-----------|-------------|------|----------|
| REV       | DESCRIPTION | DATE | APPROVED |

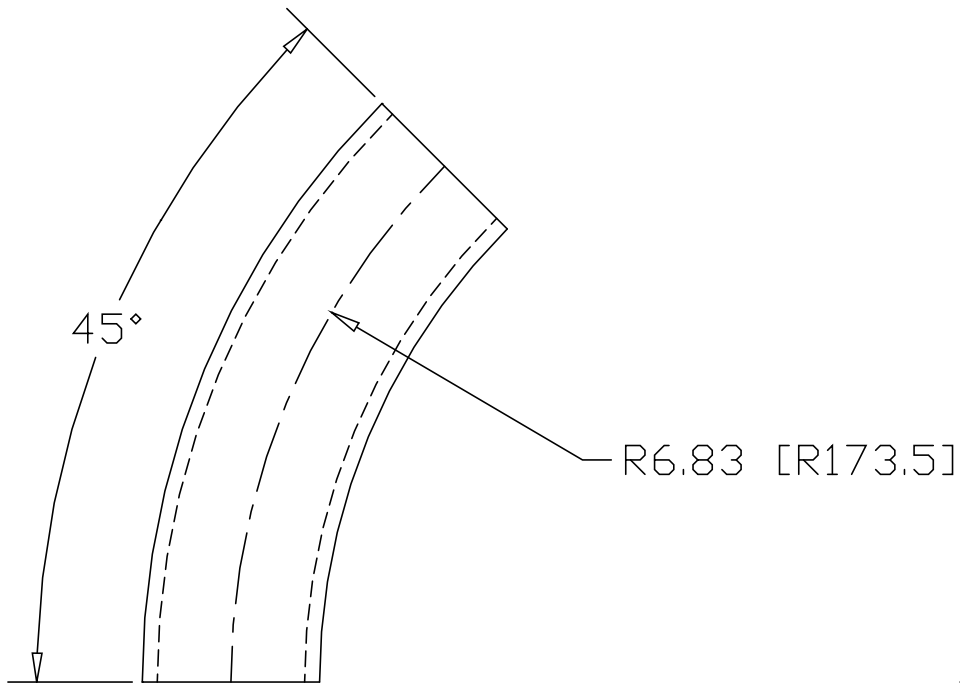

INCHES [MILLIMETERS]

| ALTERNATE MATERIAL                       | PART NUMBER |
|--|-------------|
| 1-1/4" SCH 40 (6063) ALUMINUM PIPE       | 7483        |
| 1-1/4" SCH 40 (304) STAINLESS STEEL PIPE | 7503        |

|           |         |   |          |             |      |     |  |
|-----------|---------|---|----------|-------------|------|-----|--|
| PART NAME |         | 1-1/4" PIPE SIZE 45° ELL X 6" I.R.  |          |             |      |     |  |
| MATERIAL  |         | 1-1/4" SCH 40 A53 STEEL PIPE  |          |             |      |     |  |
| DATE      | 7/05/01 |  <b>R &amp; B WAGNER, INC.</b> |          |             |      |     |  |
| DRAWN BY  | JAH     |   |          |             |      |     |  |
| FINISH    | MILL    |   |          |             |      |     |  |
| SIZE      | A       | WEIGHT  | 1.02 LBS | PART NUMBER | 7463 | REV |  |