

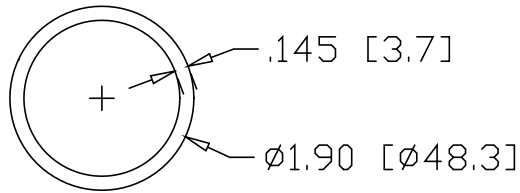

REV  
SH  
5663  
DWG NO

REVISIONS			
REV	DESCRIPTION	DATE	APPROVED

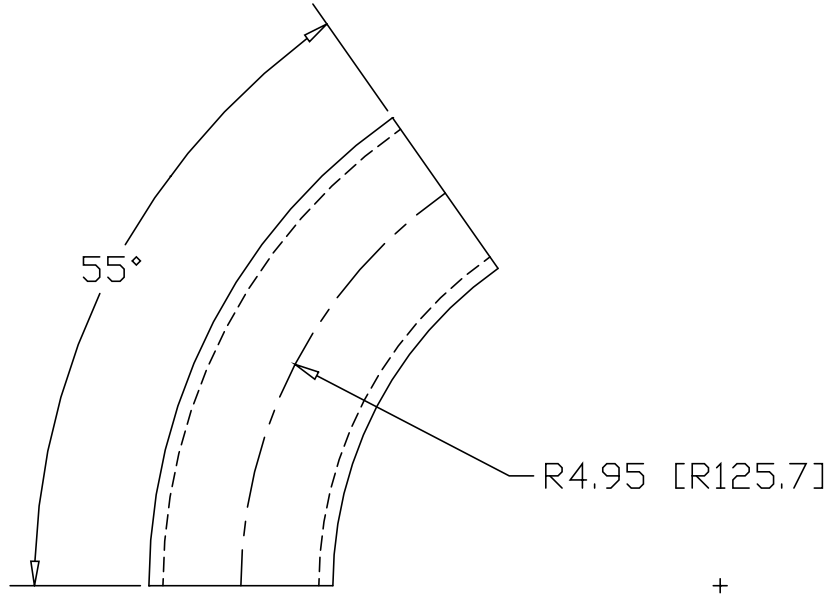

INCHES [MILLIMETERS]

ALTERNATE MATERIAL	PART NUMBER
1-1/2" SCH 40 (6063) ALUMINUM PIPE	5673
1-1/2" SCH 40 (304) STAINLESS STEEL PIPE	5683

PART NAME		1-1/2" PIPE SIZE 55° ELL X 4" I.R.					
MATERIAL		1-1/2" SCH 40 A53 STEEL PIPE					
DATE	4/5/96	 <b>R &amp; B WAGNER, INC.</b>					
DRAWN BY	RJF						
FINISH	MILL						
SIZE	A	WEIGHT	1.07 LBS	PART NUMBER	5663	REV	