

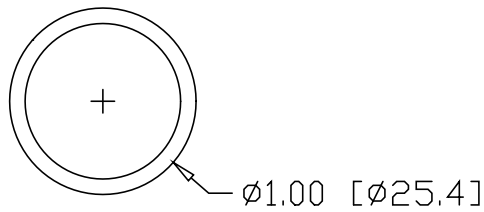

REV
SH
7809
DWG NO

REVISIONS			
REV	DESCRIPTION	DATE	APPROVED

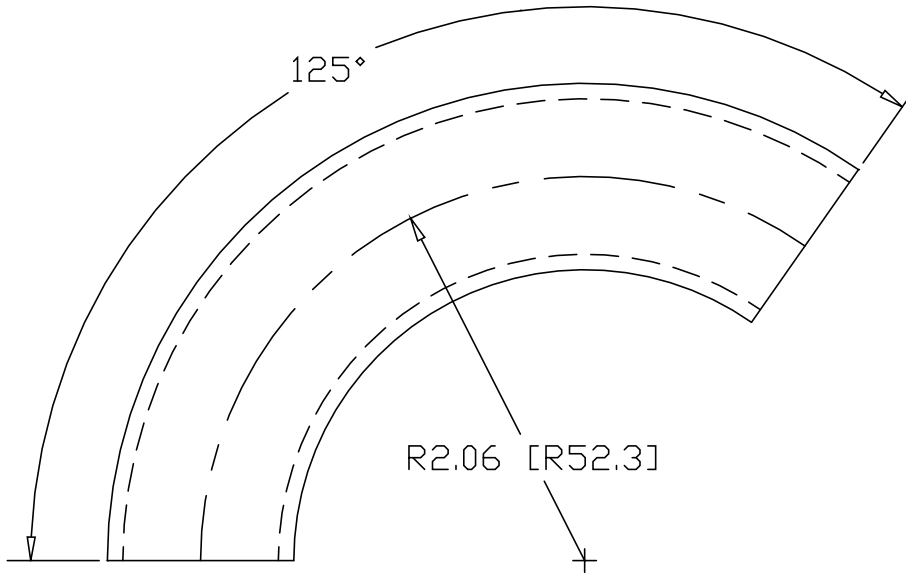

INCHES [MILLIMETERS]

PART NAME		1.00" OD TUBE 125° ELL X 2.06" CLR					
MATERIAL		1.00" OD X .083W STEEL TUBE ASTM A513					
DATE	8/10/00		THE WAGNER COMPANIES R & B WAGNER, INC. AND J. G. BRAUN CO.				
DRAWN BY	RJF						
FINISH	MILL						
SIZE	A	WEIGHT	.30 LBS	PART NUMBER	7809	REV	