

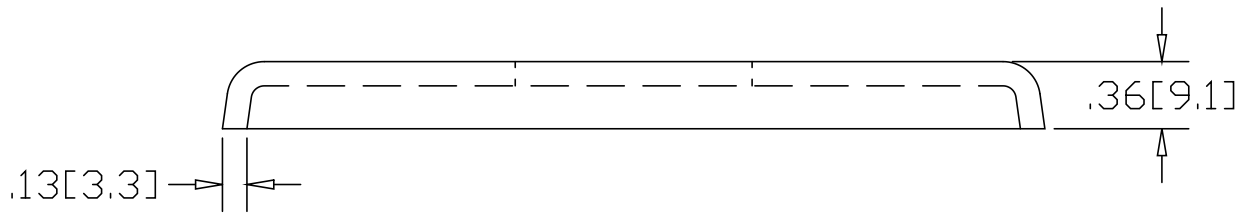

REV
SH
26404
DWG NO

REVISIONS			
REV	DESCRIPTION	DATE	APPROVED

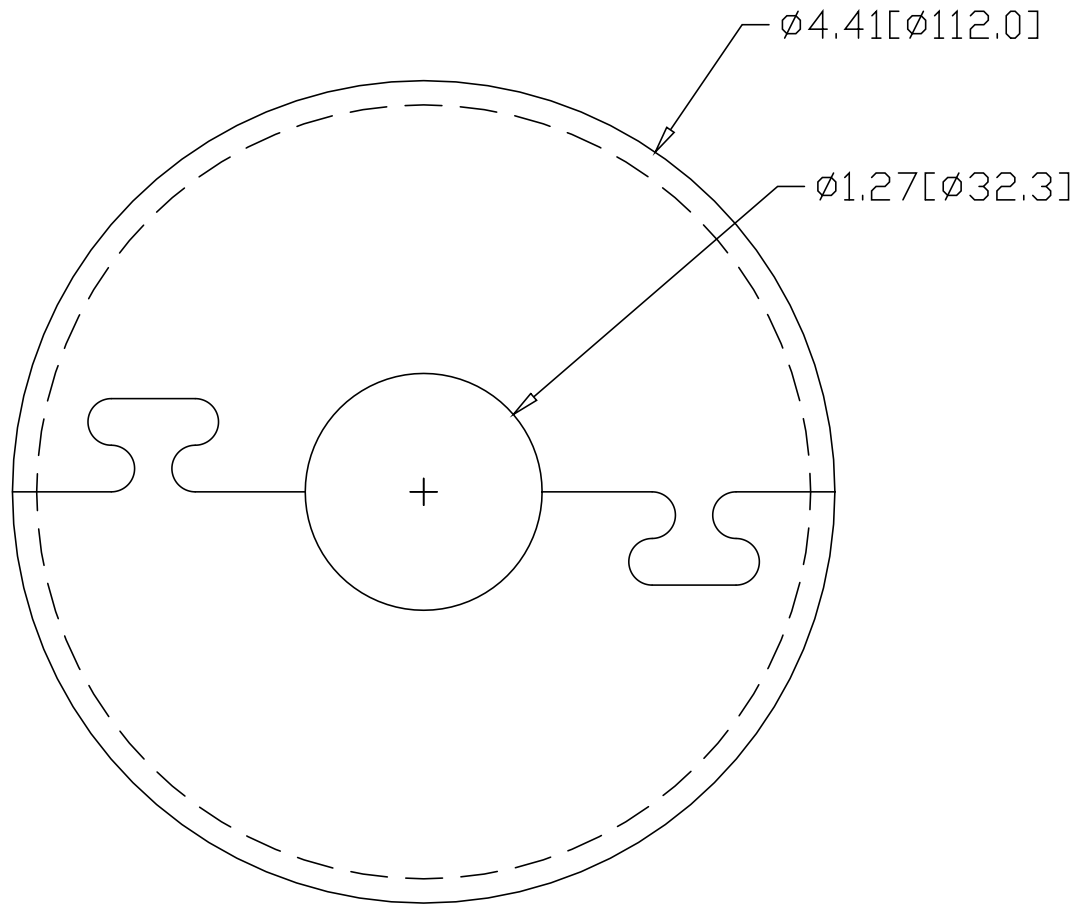

INCHES [MILLIMETERS]

ALTERNATE MATERIAL	PART NUMBER
.125 (3003) ALUMINUM ASTM B209	26414
10 GA. (304) STAINLESS STEEL ASTM A240	26424

PART NAME 1.25" OD TUBE PUZZLE-LOCK SPLIT FLANGE			
MATERIAL 10 GA. HRP&O STEEL ASTM A-569			
DATE 11/15/94		R & B WAGNER, INC.	
DRAWN BY RJF			
FINISH MILL	SIZE A	WEIGHT .63 LBS	PART NUMBER 26404
			REV