

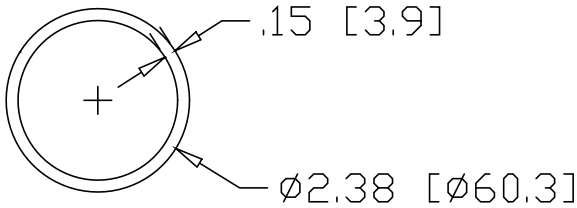

REV
SH
8102
DWG NO

REVISIONS			
REV	DESCRIPTION	DATE	APPROVED

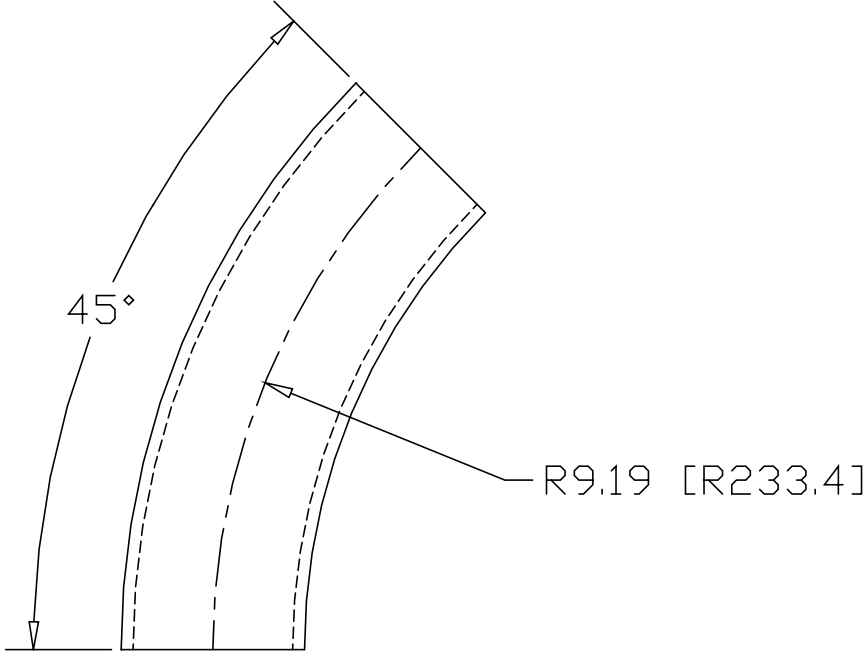

INCHES [MILLIMETERS]

ALTERNATE MATERIAL	PART NUMBER
2" SCH 40 (6063) ALUMINUM PIPE	8116
2" SCH 40 (304) STAINLESS STEEL PIPE	8130

PART NAME		2" PIPE SIZE 45° ELL X 8" I.R.					
MATERIAL		2" SCH 40 A53 STEEL PIPE					
DATE	7/31/01	 R & B WAGNER, INC.					
DRAWN BY	JAH						
FINISH	MILL						
SIZE	A	WEIGHT	2.21 LBS	PART NUMBER	8102	REV	