

REV
SH
264
DWG NO

REVISIONS			
REV	DESCRIPTION	DATE	APPROVED

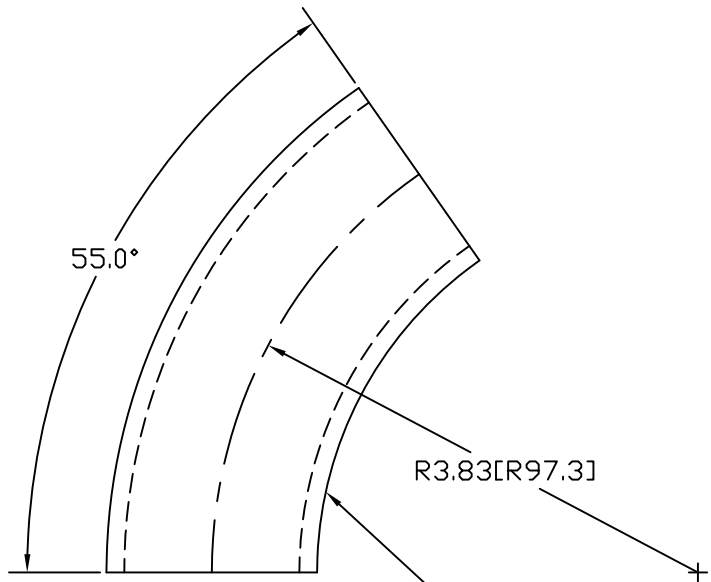

NOTE: UNWELDED SEAM
ALONG INSIDE RADIUS
(STEEL ELLS ONLY)

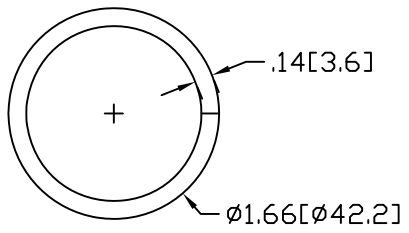

INCHES [MILLIMETERS]

ALTERNATE MATERIAL	PART NUMBER
1-1/4" SCH 40 (6063) ALUMINUM PIPE	288
1-1/4" SCH 40 (304) STAINLESS STEEL PIPE	463

PART NAME		1-1/4" PIPE SIZE 55° ELL X 3" I.R.		
MATERIAL		10 GA. HRP&D STEEL ASTM A569		
DATE	8/24/95	 R & B WAGNER, INC.		
DRAWN BY	RJF			
FINISH	MILL	SIZE	WEIGHT	PART NUMBER
		A	.69 LBS	264
				REV