

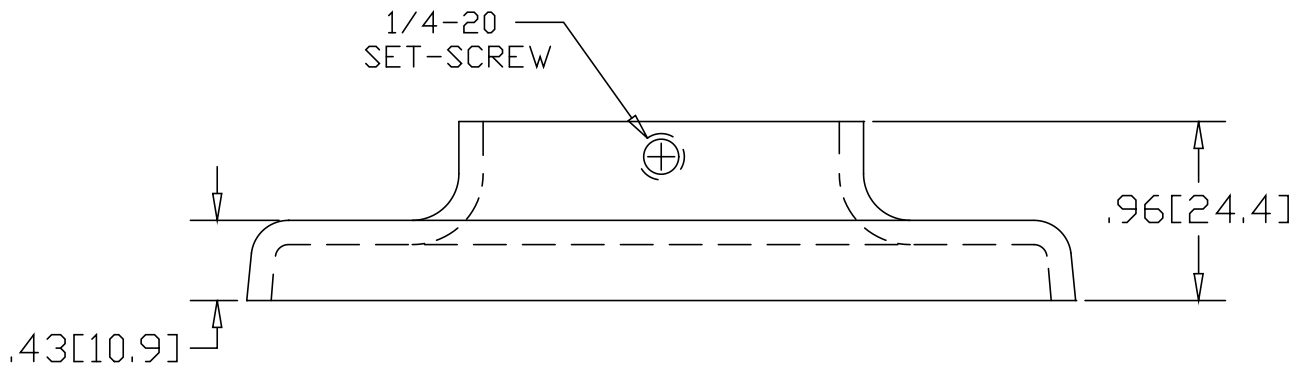

REV
SH
1437
DWG NO

REVISIONS			
REV	DESCRIPTION	DATE	APPROVED

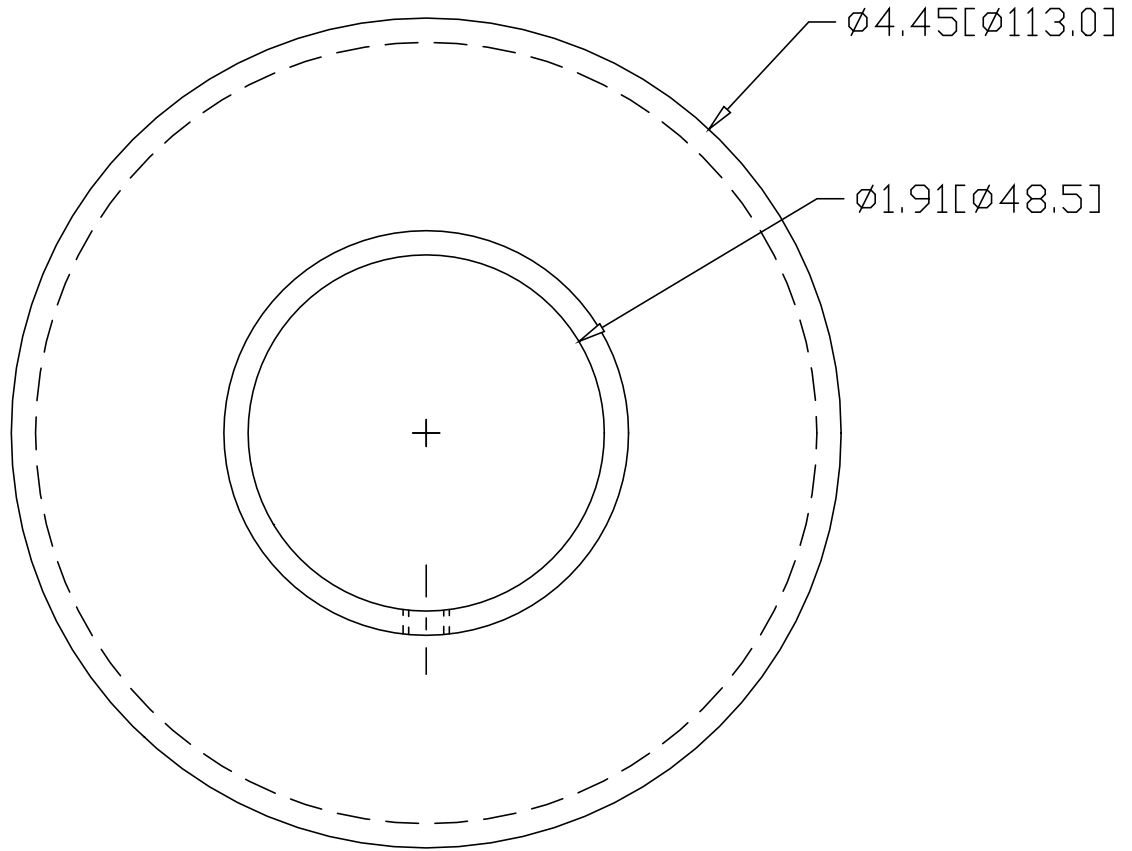

INCHES [MILLIMETERS]

ALTERNATE MATERIAL	PART NUMBER
.125 (3003) ALUMINUM ASTM B209	1477
10 GA. (304) STAINLESS STEEL ASTM A240	1537

PART NAME 1-1/2" PIPE HEAVY BASE FLANGE WITH SET-SCREW				
MATERIAL 10 GA. HRP&D STEEL ASTM A569				
DATE 9/13/94	 R & B WAGNER, INC.			
DRAWN BY RJF				
FINISH MILL	SIZE A	WEIGHT .64 LBS	PART NUMBER 1437	REV