

2

1

B

B

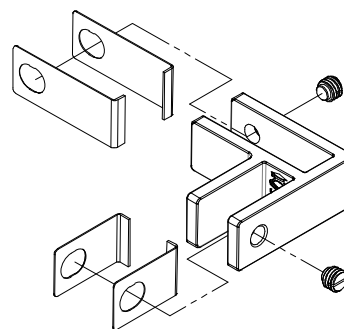
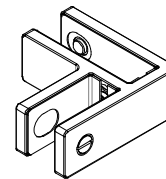
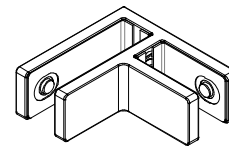
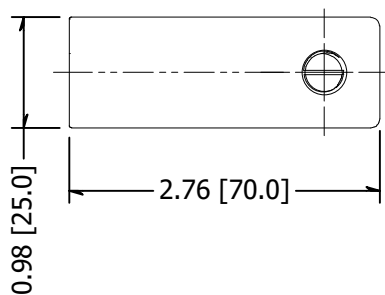
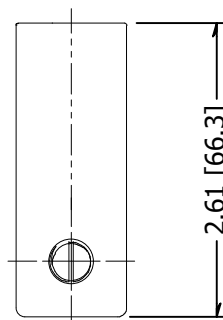
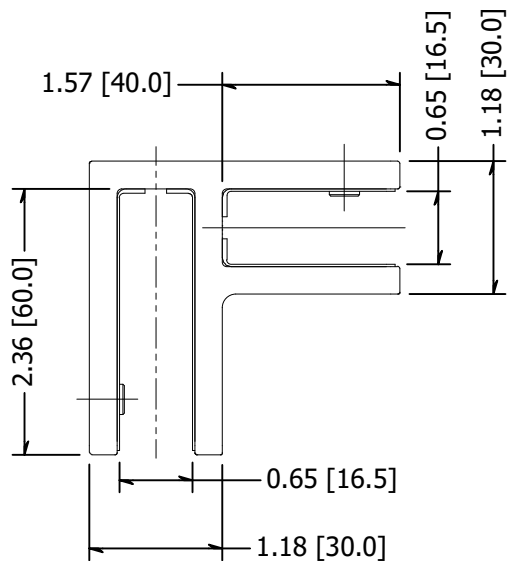

A

A

MATERIAL: 2205 Stainless	DESCRIPTION: Glass Railing Stiffener, 2205 Stainless, For Use With Glass Railing and Wall Mounted Glass, 13.52-15.04mm 90 Degree		
FINISH: #4	DATE: 6/10/2021	SCALE:	REV: -
WEIGHT:	ITEM NUMBER: GRSB9015		 10600 W Brown Deer Rd Milwaukee, WI 53224 <a href="http://www.wagnercompanies.com/">http://www.wagnercompanies.com/</a>

2

1

