

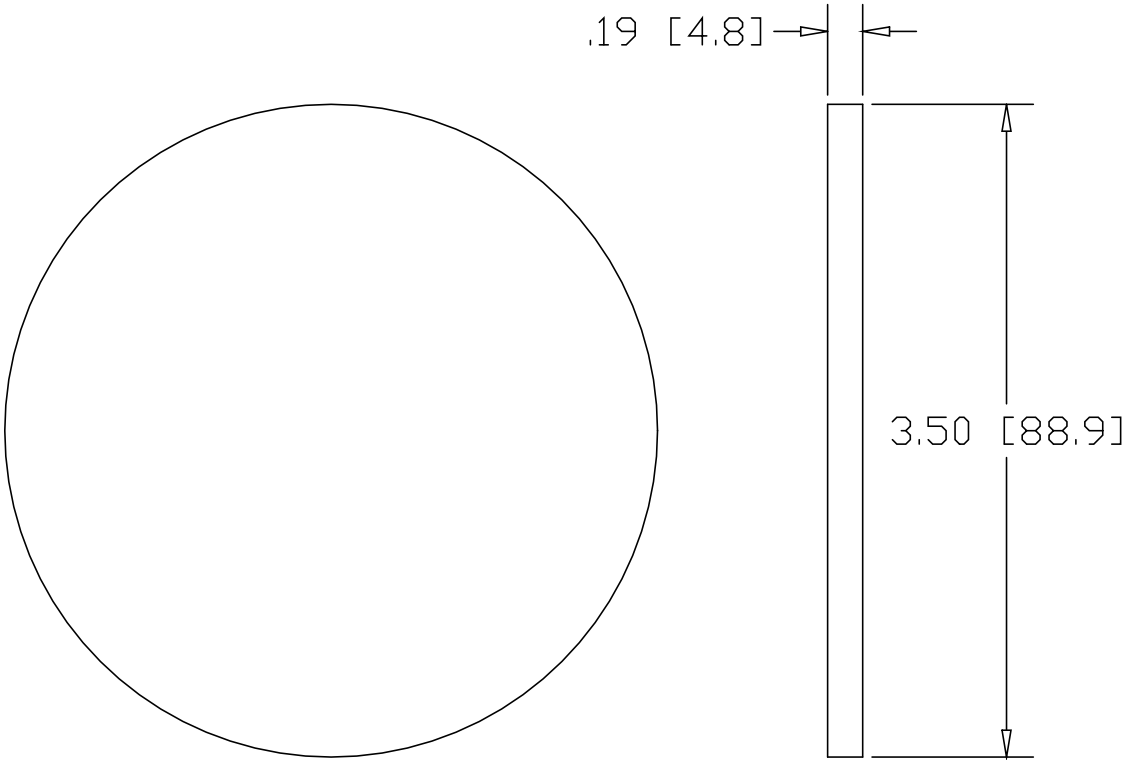

REV
SH
D169
DWG NO

REVISIONS			
REV	DESCRIPTION	DATE	APPROVED



INCHES[MILLIMETERS]

ALTERNATE MATERIAL	PART NUMBER
.190 (3003) ALUMINUM ASTM B209	D170
7 GA 304 STAINLESS STEEL ASTM A240	D171
.188 (260) BRASS ASTM B19,B36	D172

PART NAME 3.50" OD TUBE SIZE TYPE-D WELD-ON DISK			
MATERIAL 7 GA. HRP&O STEEL ASTM A569			
DATE 11/20/98		THE WAGNER COMPANIES R & B WAGNER, INC. AND J. G. BRAUN CO.	
DRAWN BY RJF			
FINISH MILL			
SIZE A	WEIGHT .55 LBS	PART NUMBER D169	REV