

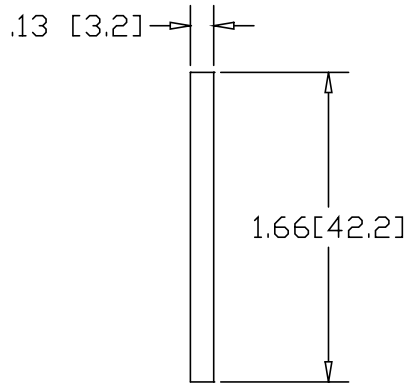

REV
SH
DWG NO D060

REVISIONS			
REV	DESCRIPTION	DATE	APPROVED

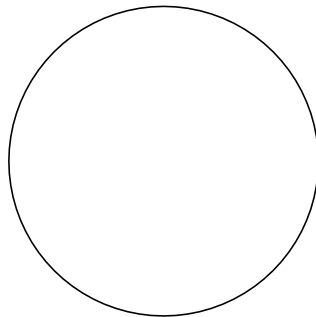
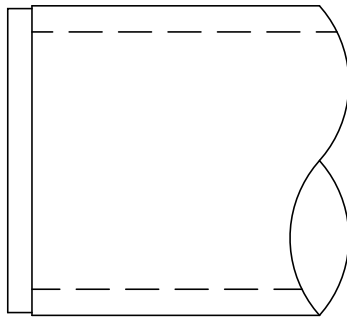
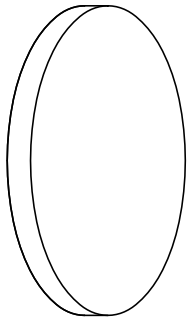

INCHES [MILLIMETERS]

ALTERNATE MATERIAL	PART NUMBER
.125 (3003) ALUMINUM ASTM B209	D061
10 GA. (304) STAINLESS STEEL ASTM A240	D062
.125 (260) BRASS ASTM B19,B36	D063

PART NAME 1-1/4" PIPE SIZE TYPE-D WELD-ON DISK				
MATERIAL 10 GA. HRP&D STEEL ASTM A569				
DATE 10/11/96		THE WAGNER COMPANIES R & B WAGNER, INC. AND J. G. BRAUN CO.		
DRAWN BY RJF				
FINISH MILL	SIZE A	WEIGHT .08 LBS	PART NUMBER D060	REV