

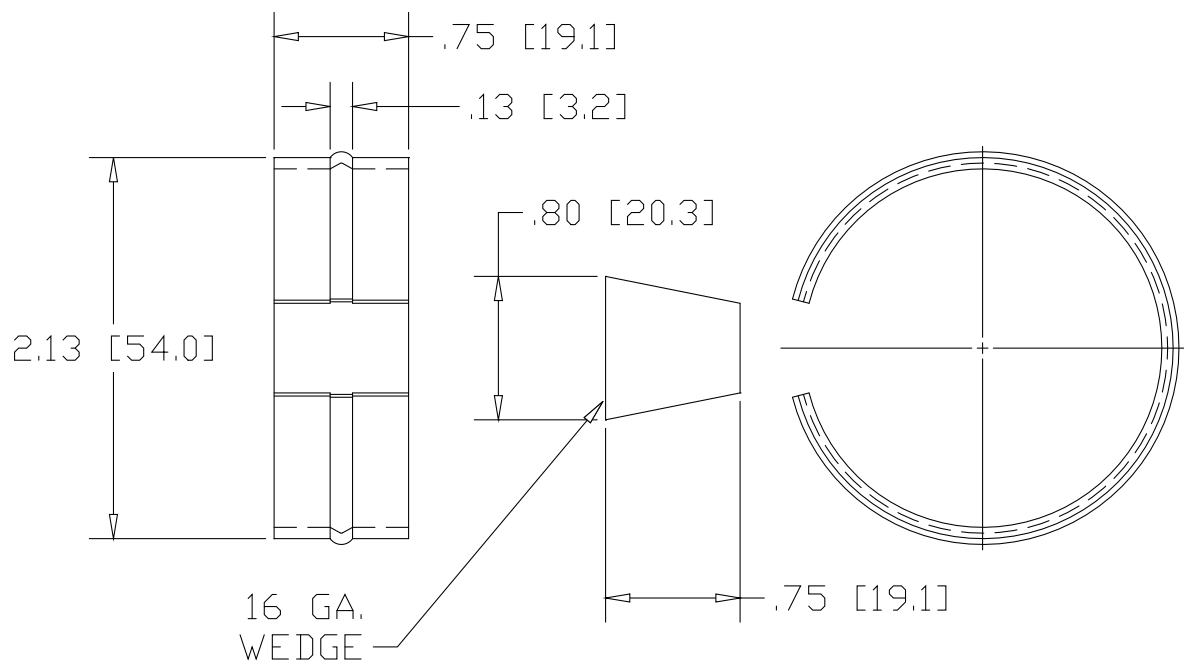

REV
SH
1043T
DWG NO

REVISIONS			
REV	DESCRIPTION	DATE	APPROVED

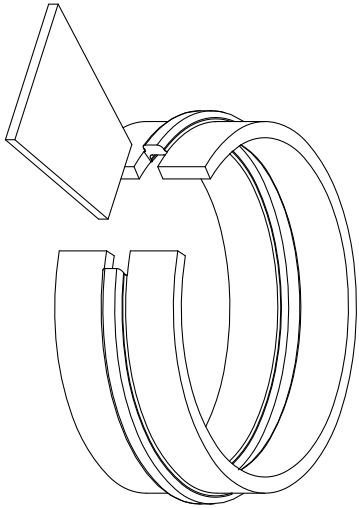

INCHES [MILLIMETERS]

ALTERNATE MATERIAL	PART NUMBER
.063 (3003) ALUMINUM ASTM B209	1044T
.0595 (304) STAINLESS STEEL ASTM A240	1045T

PART NAME 2.50" OD .120W TUBE WEDGE-LOCK WELDING CONNECTOR				
MATERIAL 16 GA. (.063) HRP&D STEEL ASTM A569				
DATE 10/10/01	 THE WAGNER COMPANIES R & B WAGNER, INC. AND J. G. BRAUN CO.			
DRAWN BY JAH				
FINISH MILL	SIZE A	WEIGHT .08 LBS	PART NUMBER 1043T	REV