

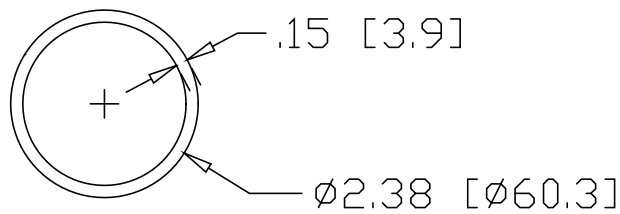

REV  
SH  
8352  
DWG NO

REVISIONS			
REV	DESCRIPTION	DATE	APPROVED

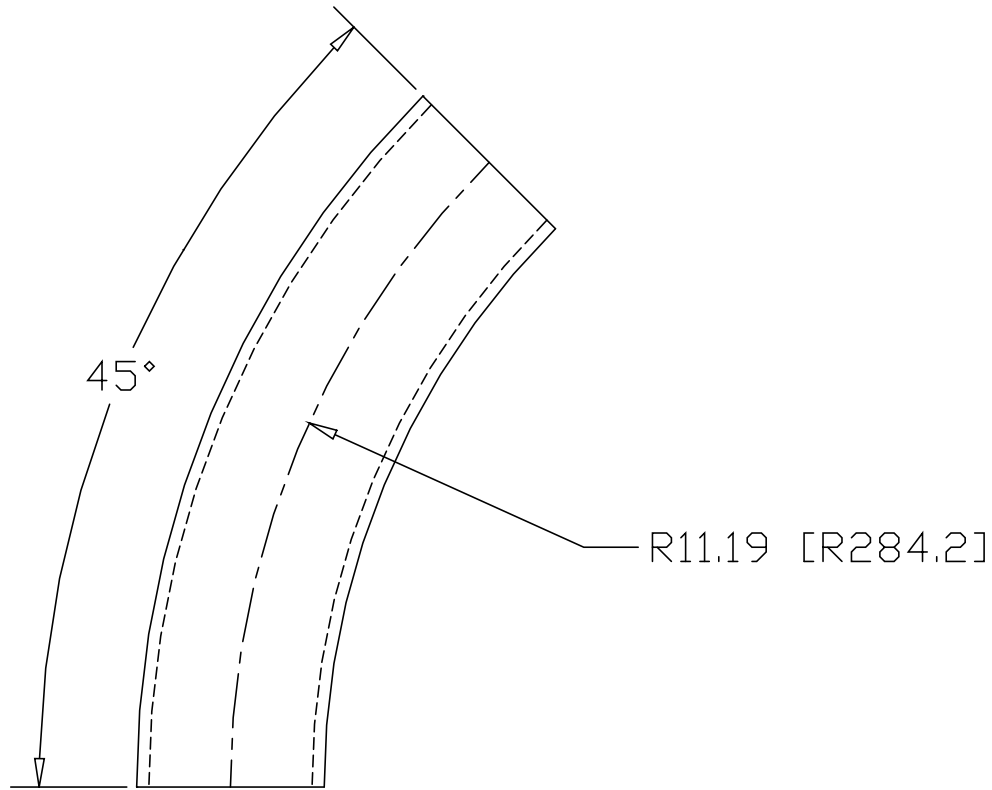

INCHES [MILLIMETERS]

ALTERNATE MATERIAL	PART NUMBER
2" SCH 40 (6063) ALUMINUM PIPE	8366
2" SCH 40 (304) STAINLESS STEEL PIPE	8380

PART NAME		2" PIPE SIZE 45° ELL X 10" I.R.					
MATERIAL		2" SCH 40 A53 STEEL PIPE					
DATE	8/7/01	 <b>R &amp; B WAGNER, INC.</b>					
DRAWN BY	JAH						
FINISH	MILL						
SIZE	A	WEIGHT	2.66 LBS	PART NUMBER	8352	REV	