

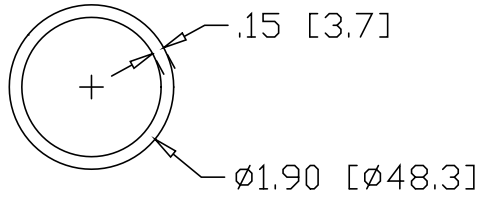

REV
SH
7750
DWG NO

REVISIONS			
REV	DESCRIPTION	DATE	APPROVED

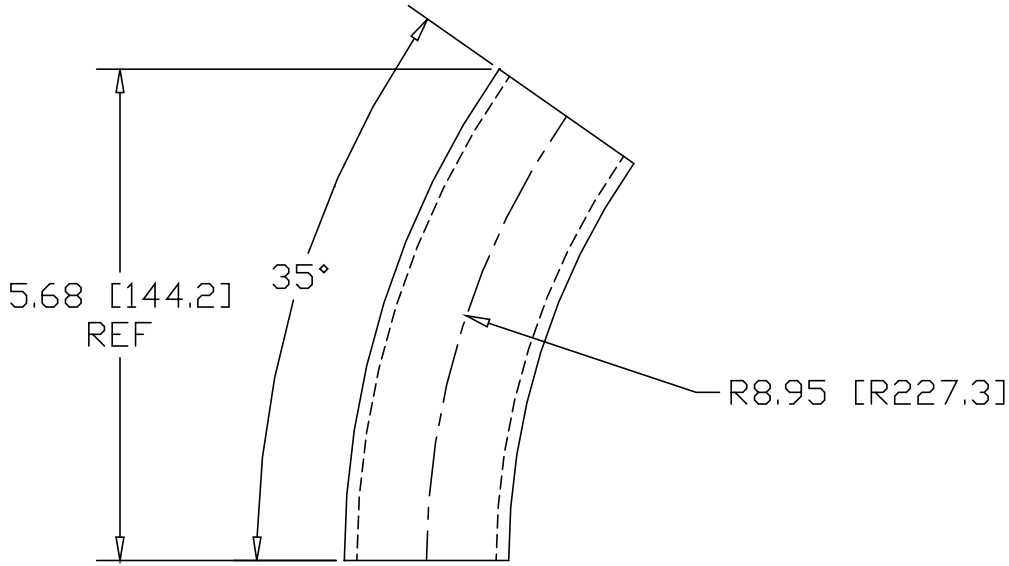

INCHES [MILLIMETERS]

ALTERNATE MATERIAL	PART NUMBER
1-1/2" SCH 40 (6063) ALUMINUM PIPE	7764
1-1/2" SCH 40 (304) STAINLESS STEEL PIPE	7778

PART NAME		1-1/2" PIPE SIZE 35° ELL X 8" I.R.				
MATERIAL		1-1/2" SCH 40 A53 STEEL PIPE				
DATE	7/30/01	 R & B WAGNER, INC.				
DRAWN BY	JAH					
FINISH	MILL					
SIZE	A	WEIGHT	1.23 LBS	PART NUMBER	7750	REV