

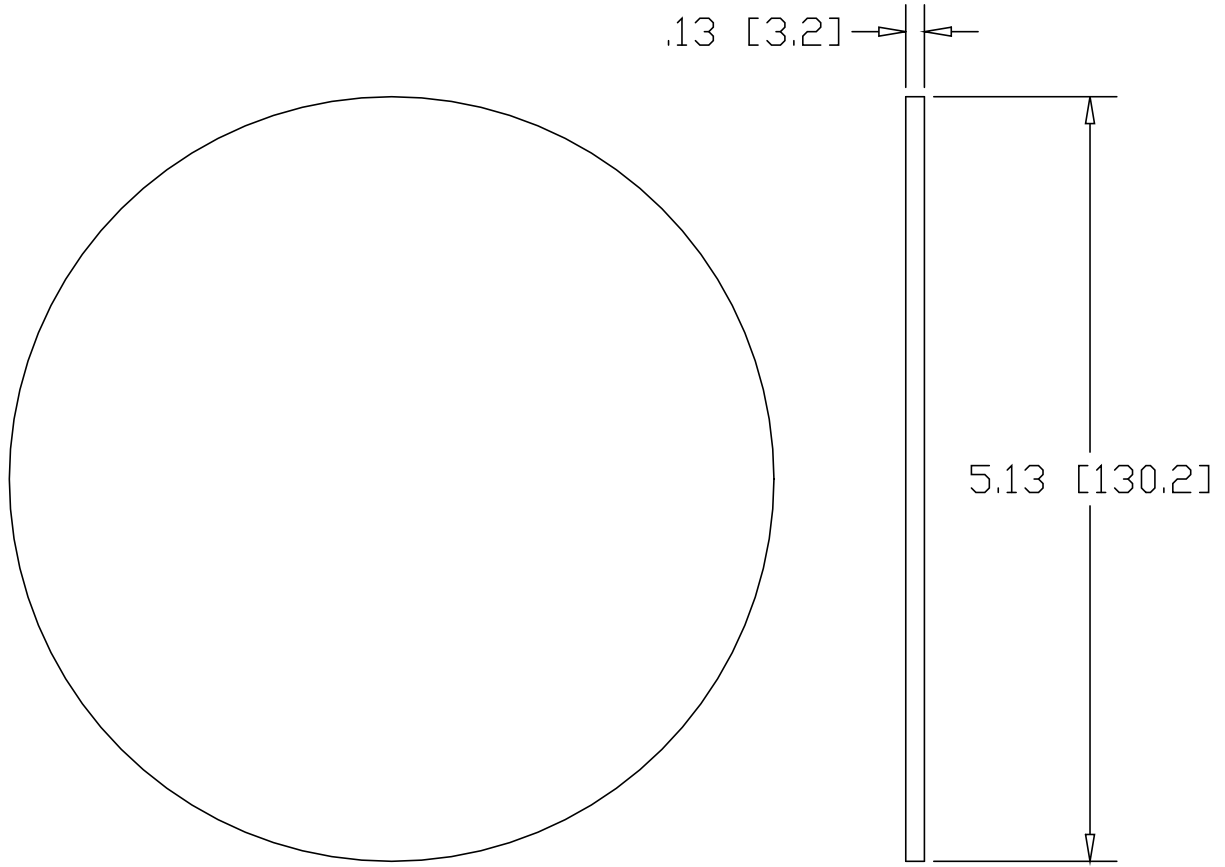

REV  
SH  
D300  
DWG NO

REVISIONS			
REV	DESCRIPTION	DATE	APPROVED



INCHES [MILLIMETERS]

ALTERNATE MATERIAL	PART NUMBER
.125 (3003) ALUMINUM ASTM B209	D301
10 GA. (304) STAINLESS STEEL ASTM A240	D302
.125 (260) BRASS ASTM B19,B36	D303

PART NAME 5.13" OD TUBE SIZE TYPE-D WELD-ON DISK			
MATERIAL 10 GA. HRP&D STEEL ASTM A569			
DATE 11/20/98		<b>THE WAGNER COMPANIES</b> R & B WAGNER, INC. AND J. G. BRAUN CO.	
DRAWN BY RJF			
FINISH MILL			
SIZE A	WEIGHT .78 LBS	PART NUMBER D300	REV