

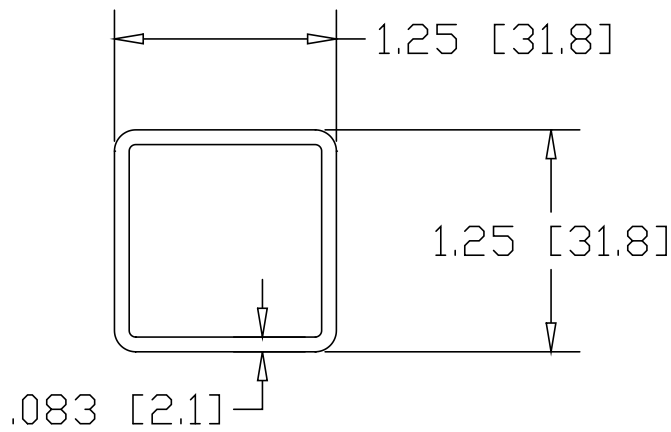

REV
SH
6334
DWG NO

REVISIONS			
REV	DESCRIPTION	DATE	APPROVED

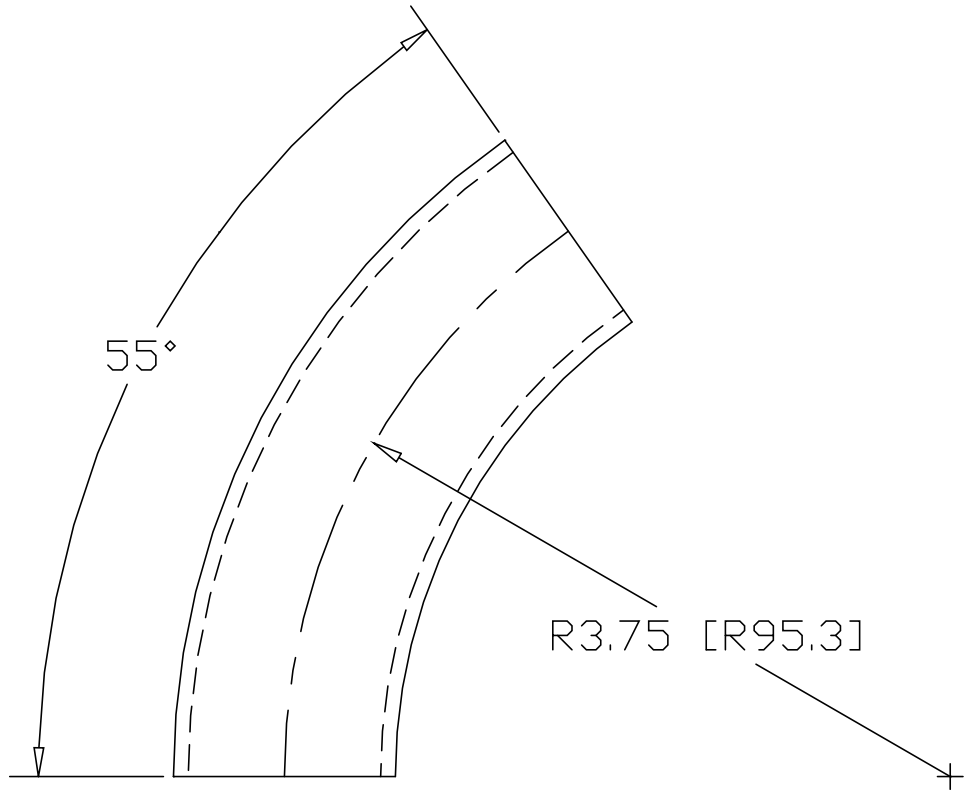

INCHES [MILLIMETERS]

PART NAME		1.25" SQUARE STEEL 55° X 3.75" CLR ELL		
MATERIAL		1.25" X .083W SQUARE STEEL TUBE		
DATE	10/3/00	 THE WAGNER COMPANIES R & B WAGNER, INC. AND J. G. BRAUN CO.		
DRAWN BY	RJF			
FINISH	MILL			
SIZE	WEIGHT	PART NUMBER	REV	
A	.40 LBS	6334		