

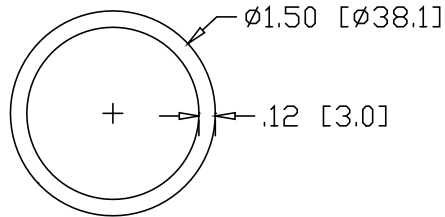

REV
SH
DWG NO 6903

REVISIONS			
REV	DESCRIPTION	DATE	APPROVED

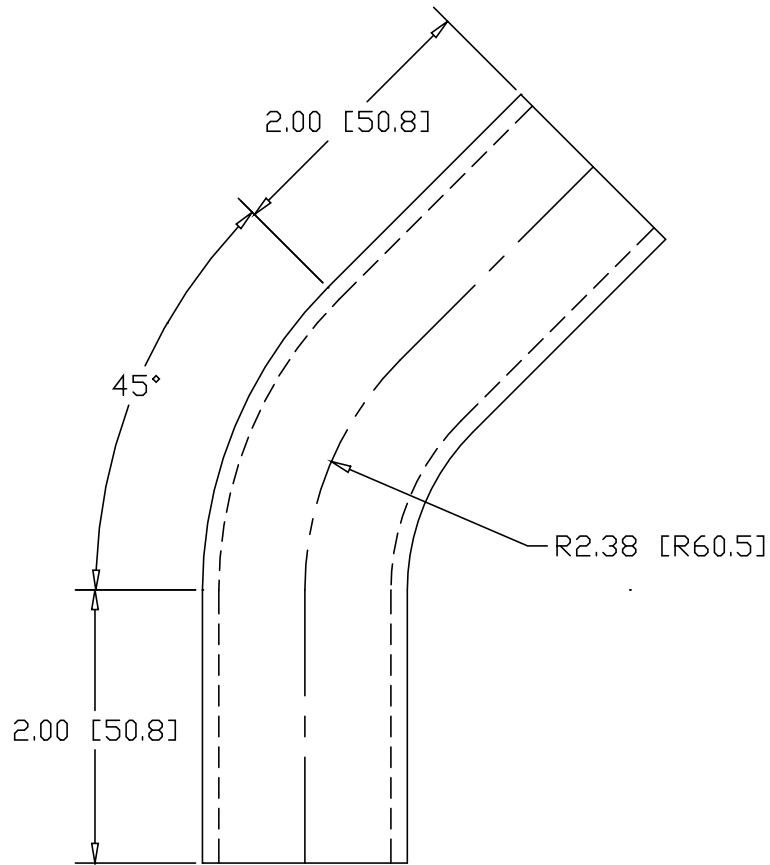

INCHES [MILLIMETERS]

ALTERNATE MATERIAL	PART NUMBER
1.50" O.D. X .125W (6061-T1) ALUMINUM TUBE	6919
1.50" O.D. X .120W (304) STAINLESS STEEL TUBE	6935

PART NAME 1.50" O.D. TUBE 45° ELL X 2.38" CLR W/(2) 2" TANGENTS				
MATERIAL 1.50" O.D. X .120W STEEL TUBE				
DATE 9/12/00	 R & B WAGNER, INC.			
DRAWN BY RJF				
FINISH MILL	SIZE A	WEIGHT .87 LBS	PART NUMBER 6903	REV