

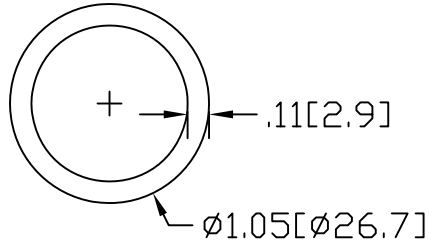

REV
SH
DWG NO 156-7

REVISIONS			
REV	DESCRIPTION	DATE	APPROVED

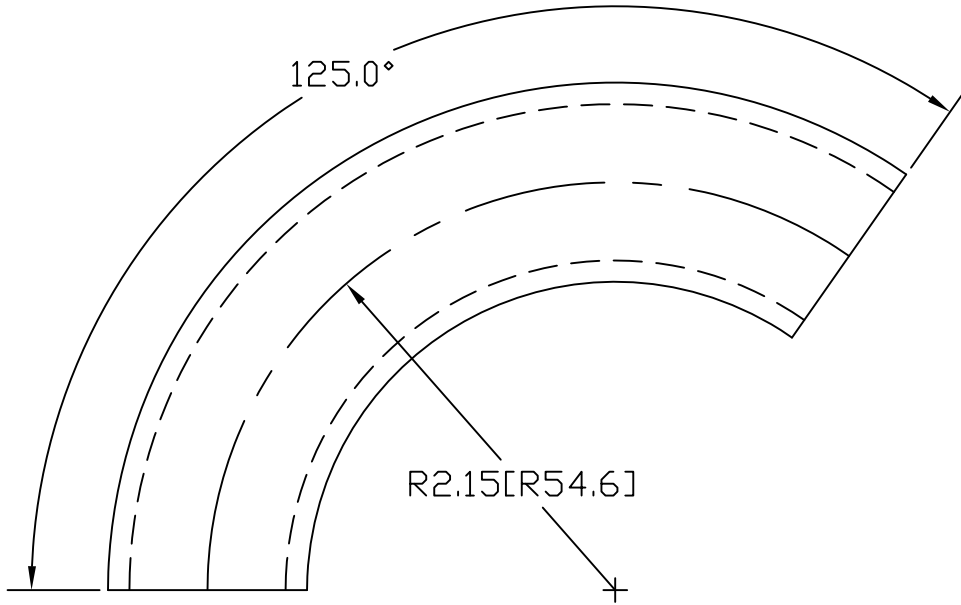

INCHES [MILLIMETERS]

ALTERNATE MATERIAL	PART NUMBER
3/4" SCH 40 (6063) ALUMINUM PIPE	166-1
3/4" SCH 40 (304) STAINLESS STEEL PIPE	176-1

PART NAME		3/4" PIPE SIZE 125° ELL X 1-5/8" I.R.		
MATERIAL		3/4" SCH 40 A53 STEEL PIPE		
DATE	8/18/95	 R & B WAGNER, INC.		
DRAWN BY	RJF			
FINISH	MILL	SIZE	WEIGHT	PART NUMBER
		A	.44 LBS	156-7
				REV