

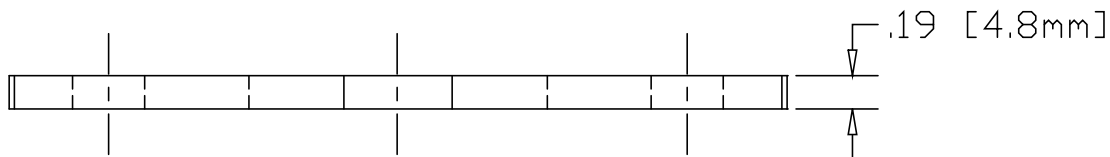

REV A
SH
DWG NO 2067B

REVISIONS			
REV	DESCRIPTION	DATE	APPROVED
A	.42 X .61 SLOTS WERE ϕ .42 HOLES	07/14/06	RJF

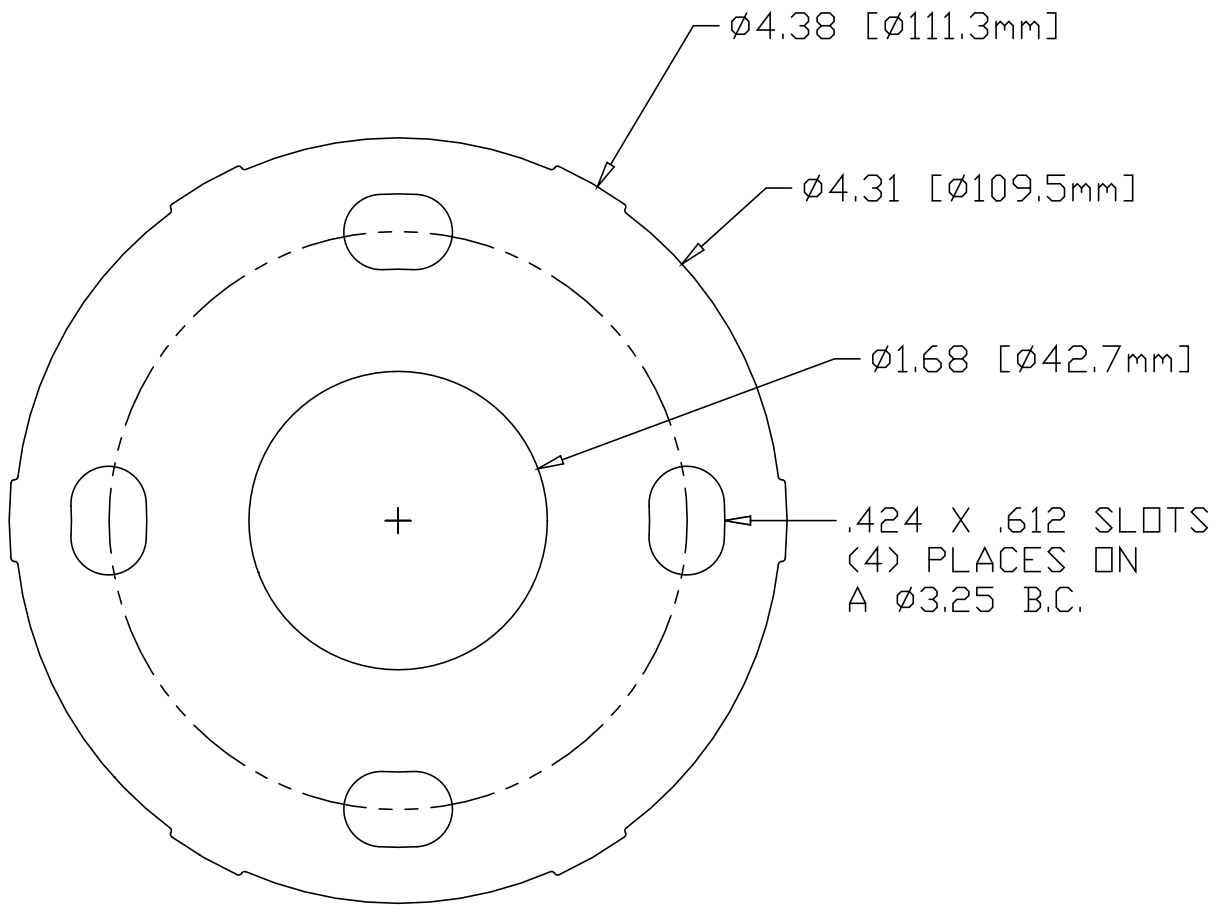

* USE WITH SNAP-COVER #2067 IN STAINLESS

INCHES [MILLIMETERS]

PART NAME		4.31" DIA SNAP COVER BASE		
MATERIAL		.188 (304) STAINLESS STEEL A240		
DATE	3/8/06	 THE WAGNER COMPANIES R & B WAGNER, INC. AND J. G. BRAUN CO.		
DRAWN BY	RDC			
FINISH	MILL			
SIZE	WEIGHT	PART NUMBER	REV	
A	.86 LBS	2067B	A	