

REV
SH
DWG NO 4462

REVISIONS			
REV	DESCRIPTION	DATE	APPROVED

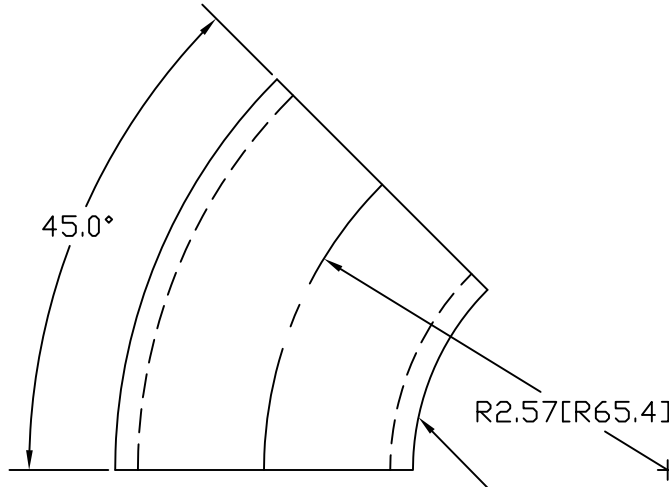

NOTE: UNWELDED SEAM ALONG INSIDE RADIUS (STEEL ELLS ONLY)

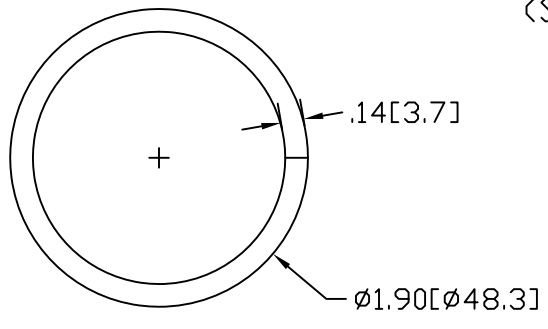

INCHES [MILLIMETERS]

ALTERNATE MATERIAL	PART NUMBER
1-1/2" SCH 40 (6063) ALUMINUM PIPE	4472
1-1/2" SCH 40 (304) STAINLESS STEEL PIPE	4682

PART NAME		1-1/2" PIPE SIZE 45° ELL X 1-5/8" I.R.		
MATERIAL		10 GA. HRP&D STEEL ASTM A569		
DATE	8/18/95	 R & B WAGNER, INC.		
DRAWN BY	RJF			
FINISH	MILL	SIZE	WEIGHT	PART NUMBER
		A	.41 LBS	4462
				REV