

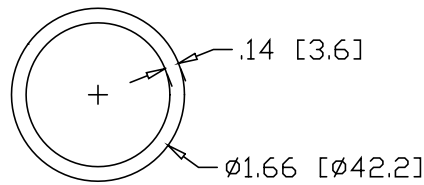

REV
SH
5634
DWG NO

REVISIONS			
REV	DESCRIPTION	DATE	APPROVED

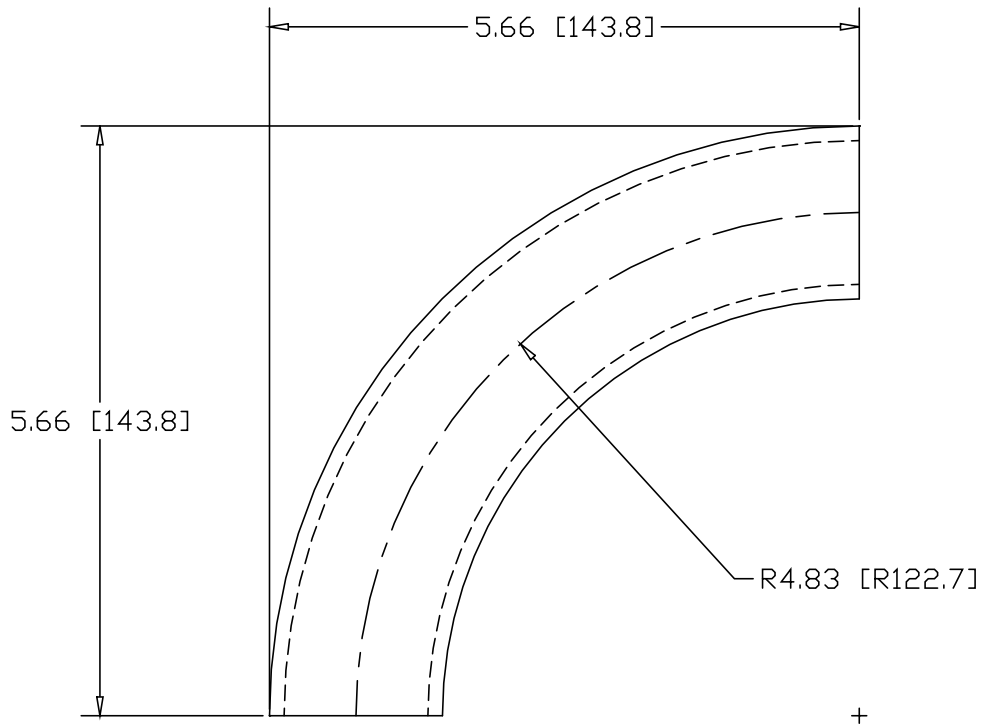

INCHES [MILLIMETERS]

ALTERNATE MATERIAL	PART NUMBER
1-1/4" SCH 40 (6063) ALUMINUM PIPE	5644
1-1/4" SCH 40 (304) STAINLESS STEEL PIPE	5654

PART NAME				1-1/4" PIPE SIZE 90° ELL X 4" I.R.		
MATERIAL				1-1/4" SCH 40 A53 STEEL PIPE		
DATE	4/5/96	 R & B WAGNER, INC.				
DRAWN BY	RJF					
FINISH	MILL					
SIZE	A	WEIGHT	1.43 LBS	PART NUMBER	5634	REV