

REV  
SH  
208  
DWG NO

REVISIONS			
REV	DESCRIPTION	DATE	APPROVED

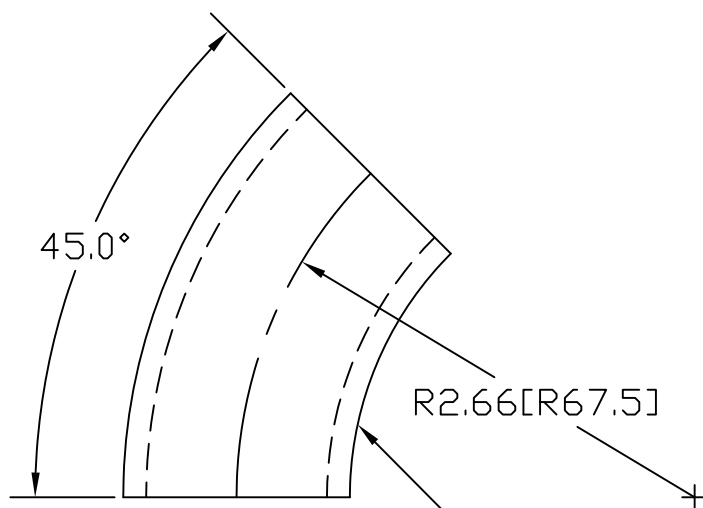

NOTE: UNWELDED SEAM  
ALONG INSIDE RADIUS  
(STEEL ELLS ONLY)

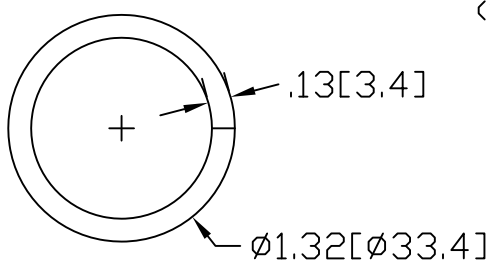

INCHES [MILLIMETERS]

ALTERNATE MATERIAL	PART NUMBER
1" SCH 40 (6063) ALUMINUM PIPE	222
1" SCH 40 (304) STAINLESS STEEL PIPE	259-S

PART NAME		1" PIPE SIZE 45° ELL X 2" I.R.		
MATERIAL		10 GA. HRP&D STEEL ASTM A569		
DATE	8/24/95	 R & B WAGNER, INC.		
DRAWN BY	RJF			
FINISH	MILL	SIZE	WEIGHT	PART NUMBER
		A	.29 LBS	208
				REV