

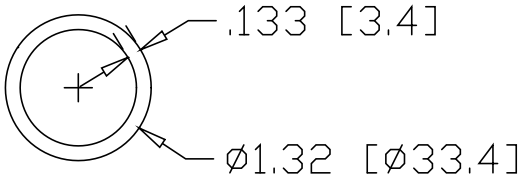

REV  
SH  
7003  
DWG NO

REVISIONS			
REV	DESCRIPTION	DATE	APPROVED

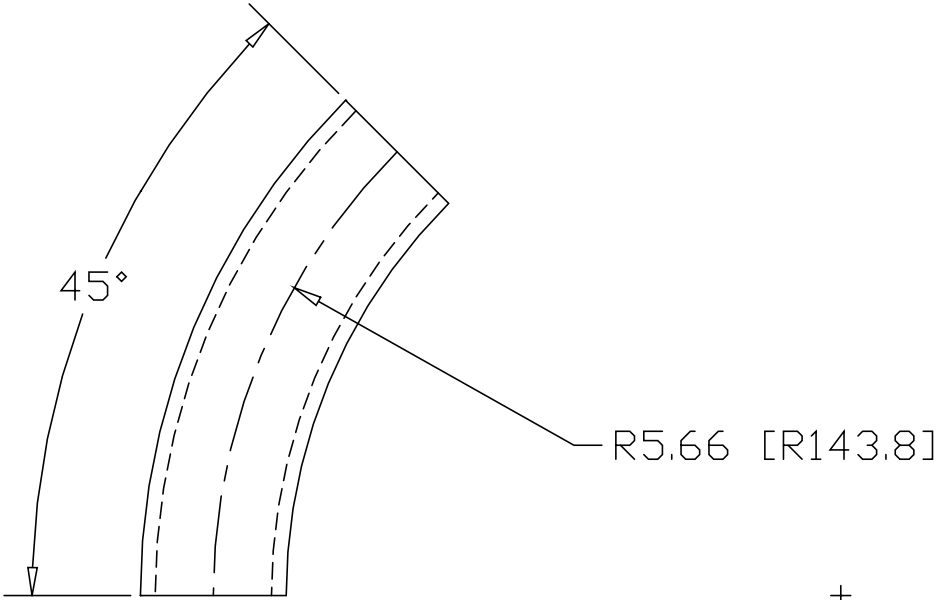

INCHES [MILLIMETERS]

ALTERNATE MATERIAL	PART NUMBER
1" SCH 40 (6063) ALUMINUM PIPE	7023
1" SCH 40 (304) STAINLESS STEEL PIPE	7043

PART NAME		1" PIPE SIZE 45° ELL X 5" I.R.					
MATERIAL		1" SCH 40 A53 STEEL PIPE					
DATE	4/30/96	 <b>R &amp; B WAGNER, INC.</b>					
DRAWN BY	RJF						
FINISH	MILL						
SIZE	A	WEIGHT	.61 LBS	PART NUMBER	7003	REV	