

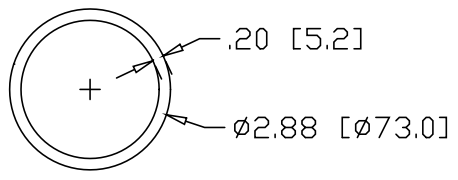

REV
SH
8150
DWG NO

REVISIONS			
REV	DESCRIPTION	DATE	APPROVED

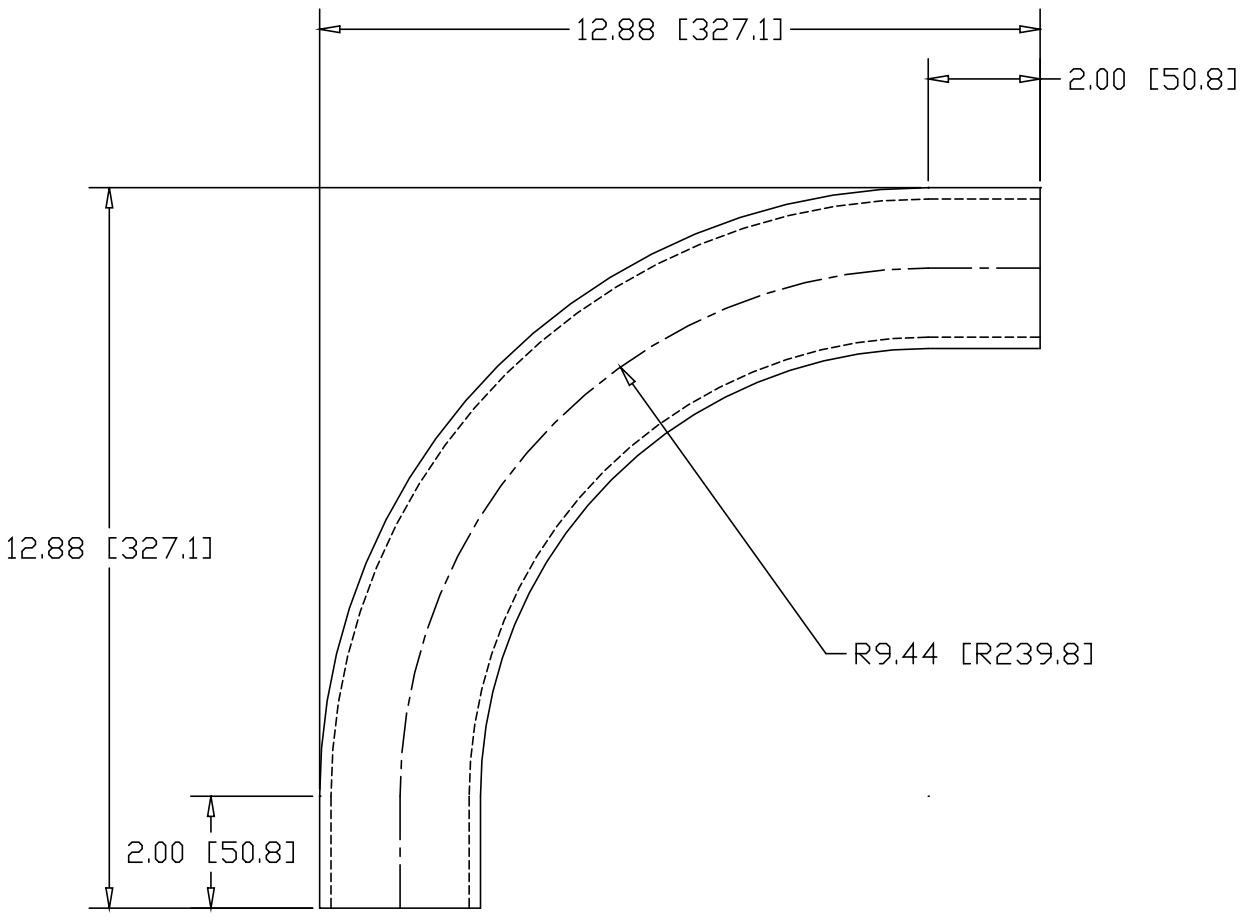

INCHES [MILLIMETERS]

ALTERNATE MATERIAL	PART NUMBER
2-1/2" SCH 40 (6063) ALUMINUM PIPE	8164
2-1/2" SCH 40 (304) STAINLESS STEEL PIPE	8178

PART NAME 2-1/2" PIPE SIZE 90° ELL X 8" I.R. W/ (2) 2" TANGENTS			
MATERIAL 2-1/2" SCH 40 A53 STEEL PIPE			
DATE 7/31/01		R & B WAGNER, INC.	
DRAWN BY JAH		SIZE A	WEIGHT 9.04 LBS
FINISH MILL		PART NUMBER 8150	REV