

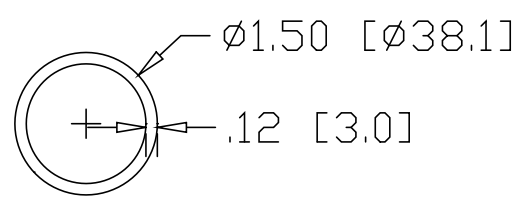

REV
SH
6956-6
DWG NO

REVISIONS			
REV	DESCRIPTION	DATE	APPROVED

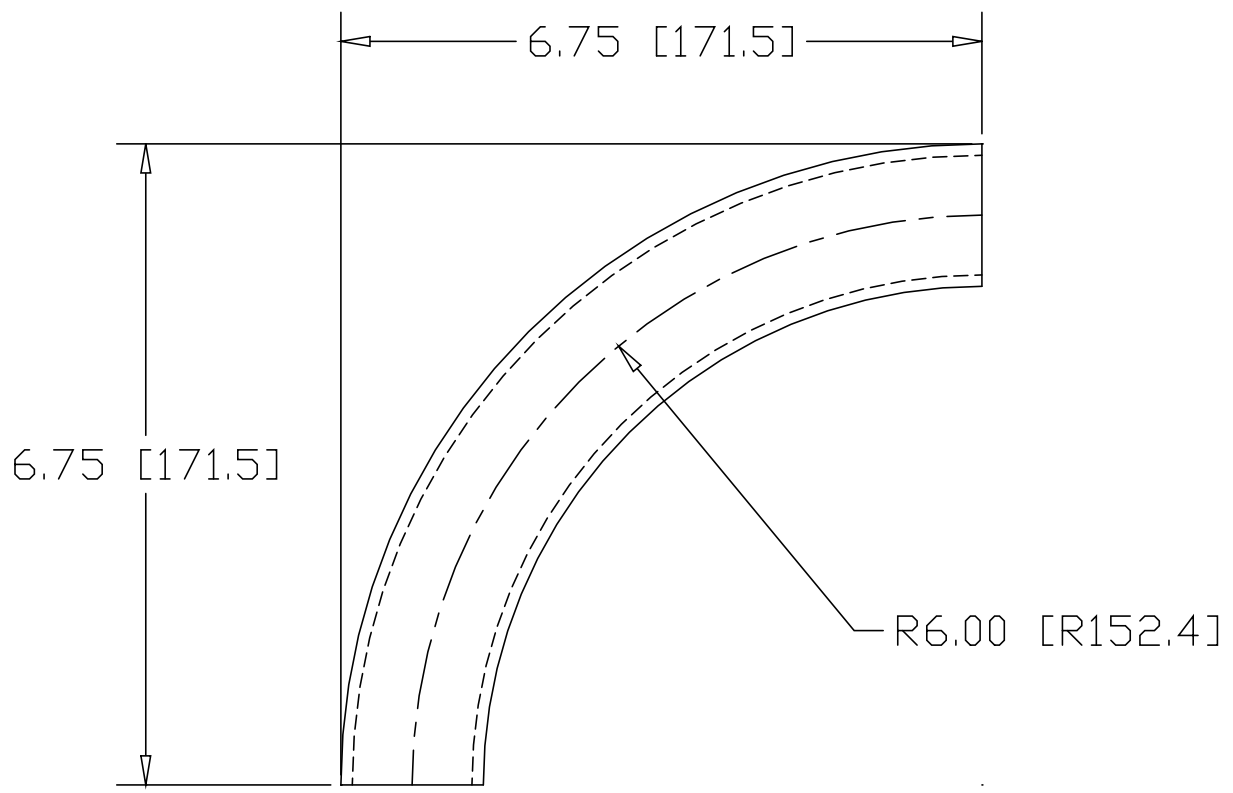

INCHES [MILLIMETERS]

ALTERNATE MATERIAL	PART NUMBER
1.50" O.D. X .125W (6061-T1) ALUMINUM TUBE	6967-6
1.50" O.D. X .120W (304) STAINLESS STEEL TUBE	6975-6

PART NAME		1.50" O.D. TUBE 90° ELL X 6.00"CLR					
MATERIAL		1.50" O.D. X .120W STEEL TUBE					
DATE	9/22/00	 R & B WAGNER, INC.					
DRAWN BY	RJF						
FINISH	MILL						
SIZE	A	WEIGHT	1.39 LBS	PART NUMBER	6956-6	REV	