

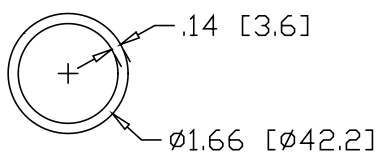

REV  
SH  
7471  
DWG NO

REVISIONS			
REV	DESCRIPTION	DATE	APPROVED

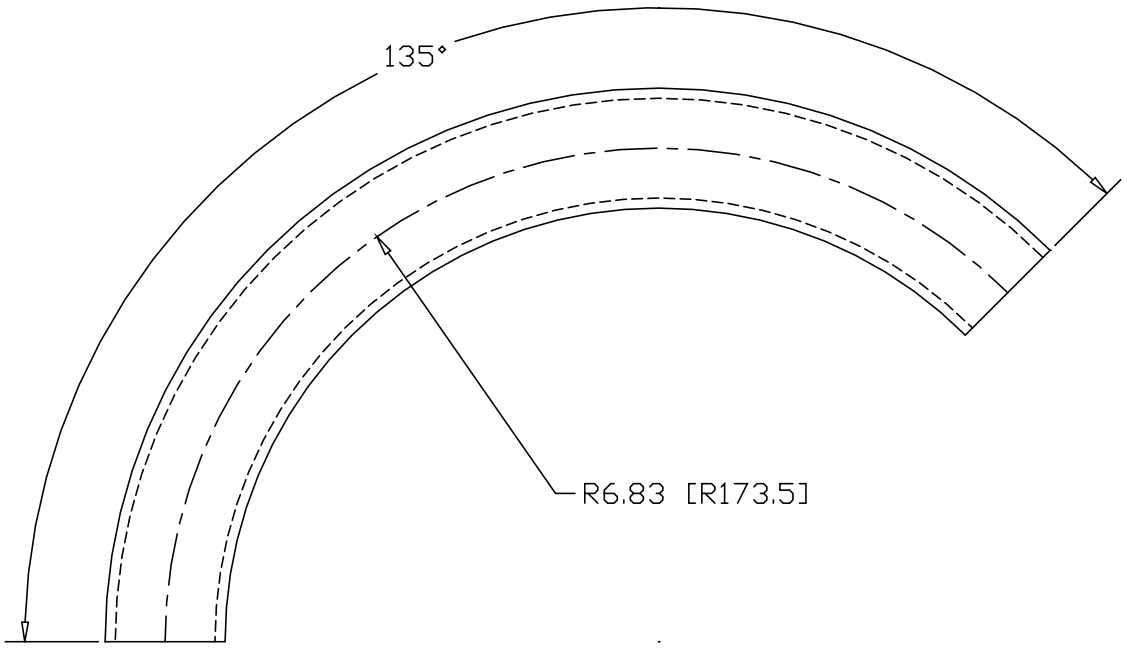

INCHES [MILLIMETERS]

PART NAME		1-1/4" PIPE SIZE 135° ELL X 6" I.R.					
MATERIAL		1-1/4" SCH 40 A53 STEEL PIPE					
DATE	7/05/01		<b>THE WAGNER COMPANIES</b> R & B WAGNER, INC. AND J. G. BRAUN CO.				
DRAWN BY	JAH						
FINISH	MILL						
SIZE	A	WEIGHT	3.05 LBS	PART NUMBER	7471	REV	