

REV
A
SH
AS2007
DWG NO

REVISIONS			
REV	DESCRIPTION	DATE	APPROVED
A	ADDED C'BORE	09/29/06	RJF

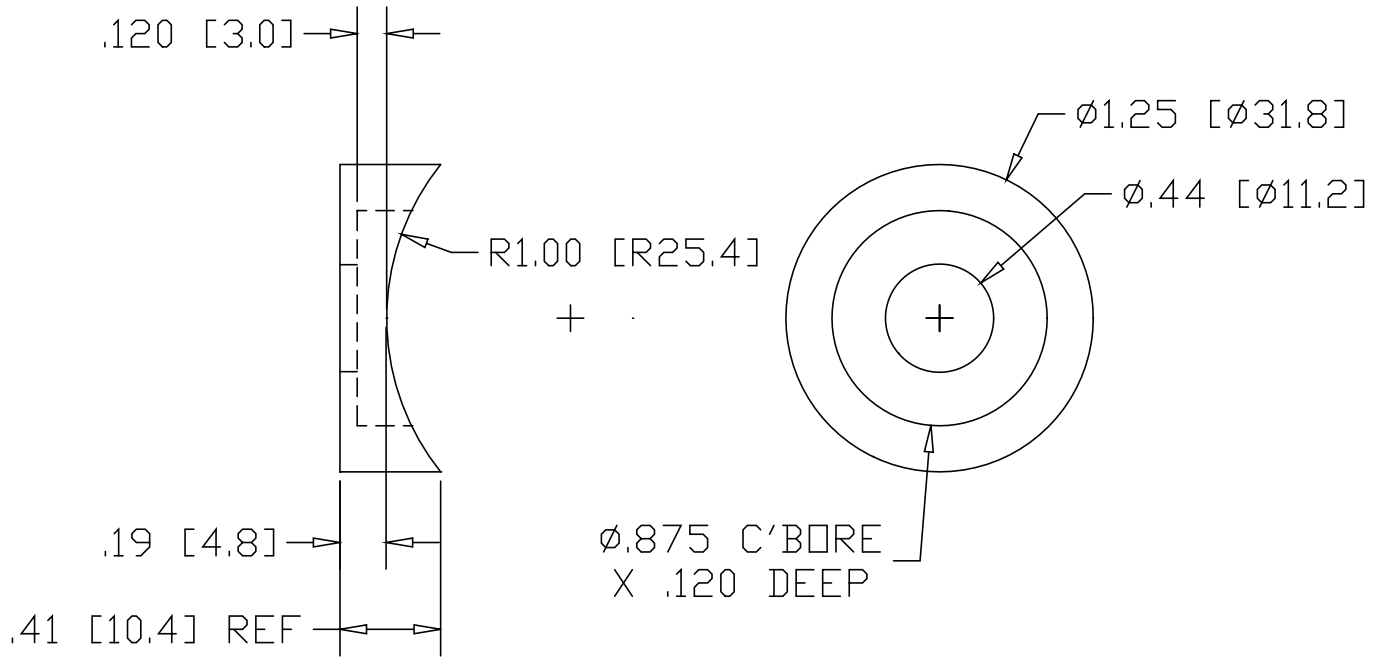

* BREAK SHARP CORNERS .015 TYPICAL

INCHES [MILLIMETERS]

PART NAME		HANDRAIL MOUNT ADAPTER "A" FOR 2.00" OD POST		
MATERIAL		Ø1.25" (304) STAINLESS STEEL		
DATE	5/5/99		THE WAGNER COMPANIES R & B WAGNER, INC. AND J. G. BRAUN CO.	
DRAWN BY	RJF			
FINISH	#4 SATIN			
SIZE	A	WEIGHT	PART NUMBER	AS2007
				REV A