

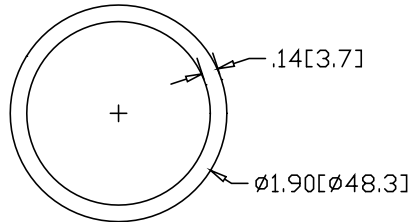

REV
SH
343-3
DWG NO

REVISIONS			
REV	DESCRIPTION	DATE	APPROVED

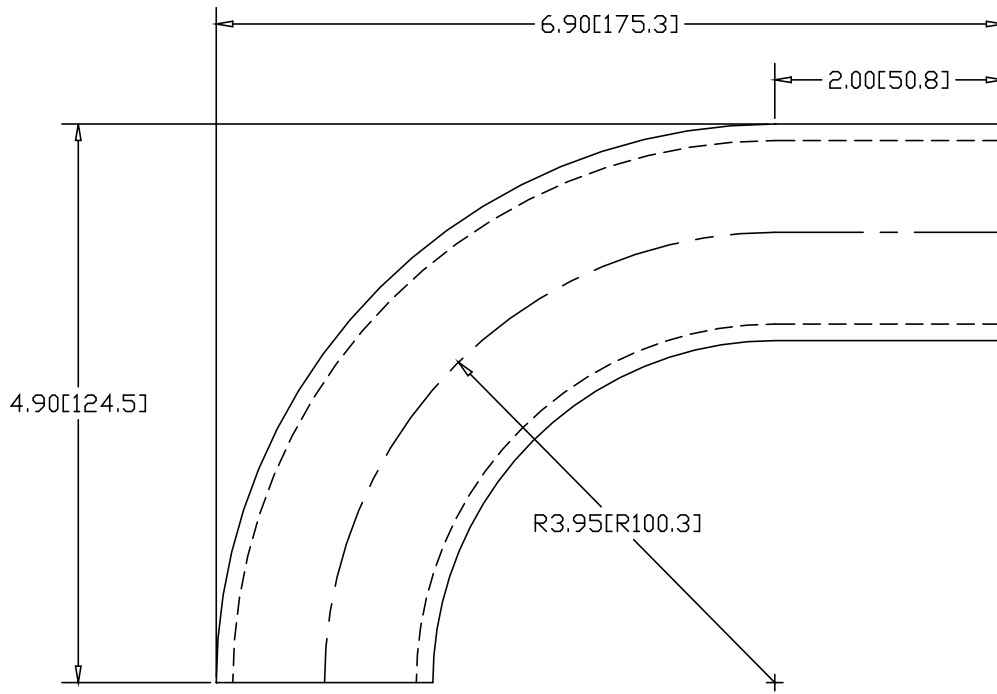

INCHES [MILLIMETERS]

ALTERNATE MATERIAL	PART NUMBER
1-1/2" SCH 40 (6063) ALUMINUM PIPE	367-3
1-1/2" SCH 40 (304) STAINLESS STEEL PIPE	391-1

PART NAME 1-1/2" PIPE SIZE 90° ELL X 3" I.R. W/(1) 2" TANGENT			
MATERIAL 1-1/2" SCH 40 STEEL PIPE			
DATE 9/12/95		R & B WAGNER, INC.	
DRAWN BY RJF			
FINISH MILL		SIZE A	WEIGHT 1.8 LBS
			REV