

REV  
SH  
DWG NO 336

REVISIONS			
REV	DESCRIPTION	DATE	APPROVED

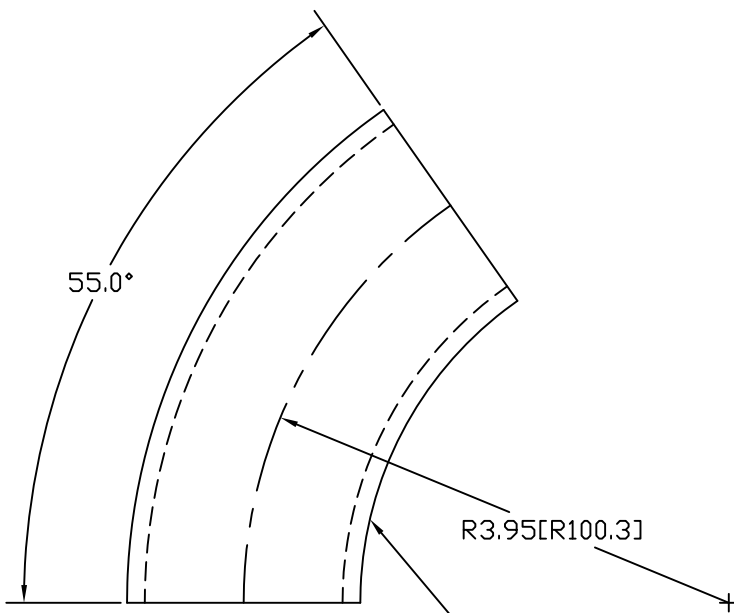

NOTE: UNWELDED SEAM  
ALONG INSIDE RADIUS  
(STEEL ELLS ONLY)

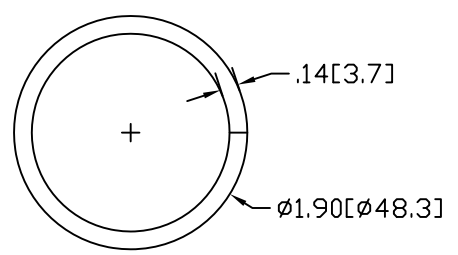

INCHES [MILLIMETERS]

ALTERNATE MATERIAL	PART NUMBER
1-1/2" SCH 40 (6063) ALUMINUM PIPE	360
1-1/2" SCH 40 (304) STAINLESS STEEL PIPE	385

PART NAME		1-1/2" PIPE SIZE 55° ELL X 3" I.R.		
MATERIAL		10 GA. HRP&D STEEL ASTM A569		
DATE	9/12/95	 R & B WAGNER, INC.		
DRAWN BY	RJF			
FINISH	MILL	SIZE	WEIGHT	PART NUMBER
		A	.84 LBS	336
				REV