

REV  
SH  
6959  
DWG NO

REVISIONS			
REV	DESCRIPTION	DATE	APPROVED

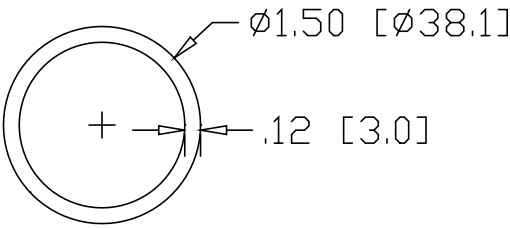
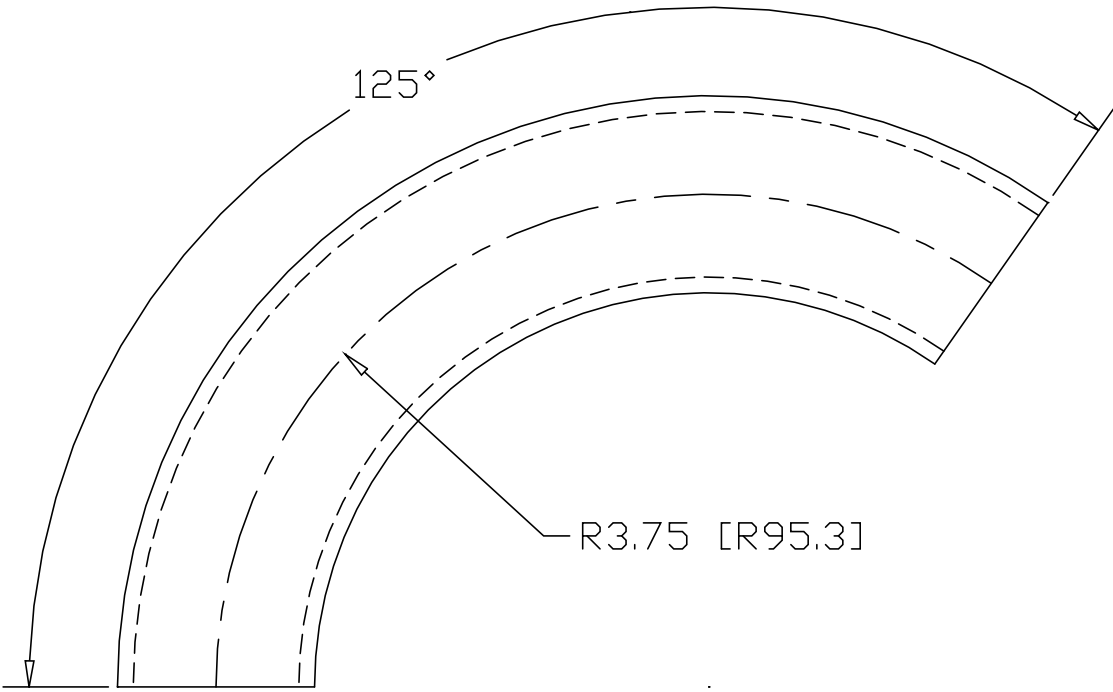

INCHES [MILLIMETERS]

PART NAME		1.50" O.D. TUBE 125° ELL X 3.75" CLR		
MATERIAL		1.50" O.D. X .120W STEEL TUBE		
DATE	9/22/00		THE WAGNER COMPANIES R & B WAGNER, INC. AND J. G. BRAUN CO.	
DRAWN BY	RJF			
FINISH				
MILL	SIZE A	WEIGHT 1.21 LBS	PART NUMBER 6959	REV