

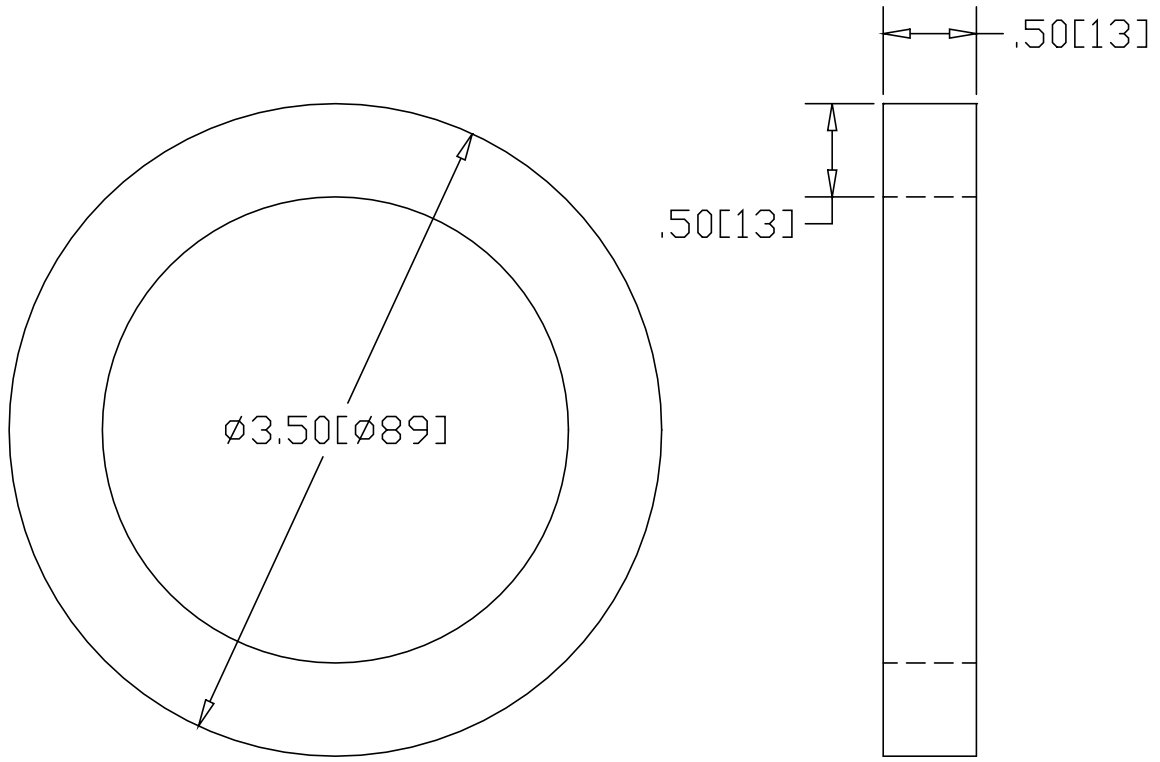

REV
SH
4384
DWG NO

REVISIONS			
REV	DESCRIPTION	DATE	APPROVED



INCHES [MILLIMETERS]

ALTERNATE MATERIAL	PART NUMBER
3.50" OD X .50 WALL (6063) ALUMINUM TUBE	4385

PART NAME .50" SQUARE X 3.50" OUTSIDE DIAMETER RING				
MATERIAL 3.50" OD X .50 WALL STEEL TUBE				
DATE 7/3/96		THE WAGNER COMPANIES R & B WAGNER, INC. AND J. G. BRAUN CO.		
DRAWN BY RJF				
FINISH SAWCUT TUMBLE DEBUR	SIZE A	WEIGHT .67 LBS	PART NUMBER 4384	REV