

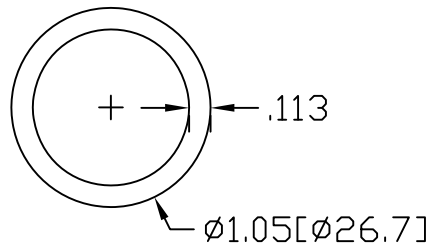

REV
SH
DWG NO 153-1

REVISIONS			
REV	DESCRIPTION	DATE	APPROVED

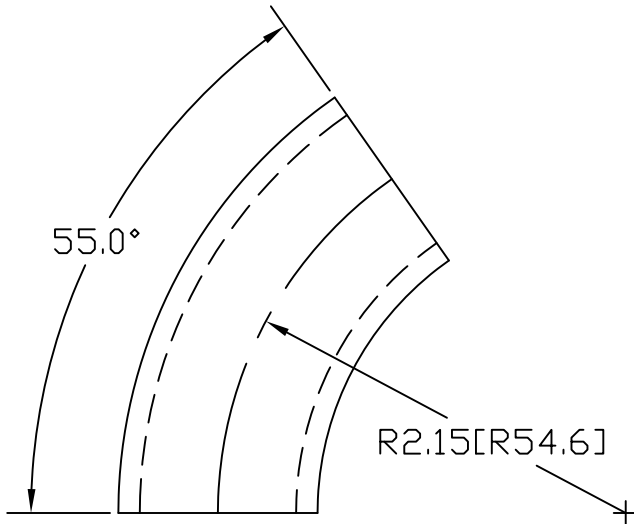

INCHES [MILLIMETERS]

ALTERNATE MATERIAL	PART NUMBER
3/4" SCH 40 (6063) ALUMINUM PIPE	163-1
3/4" SCH 40 (304) STAINLESS STEEL PIPE	173-1

PART NAME		3/4" PIPE SIZE 55° ELL X 1-5/8" I.R.		
MATERIAL		3/4" SCH 40 A53 STEEL PIPE		
DATE	8/18/95	 R & B WAGNER, INC.		
DRAWN BY	RJF			
FINISH	MILL	SIZE	WEIGHT	PART NUMBER
		A	.18 LBS	153-1
				REV