

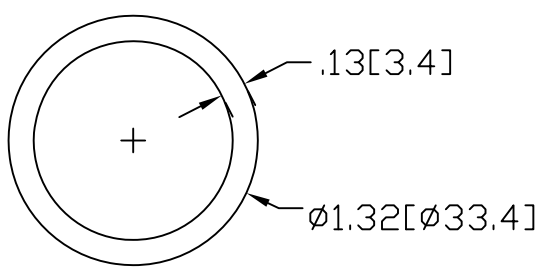

REV  
SH  
4511  
DWG NO

REVISIONS			
REV	DESCRIPTION	DATE	APPROVED

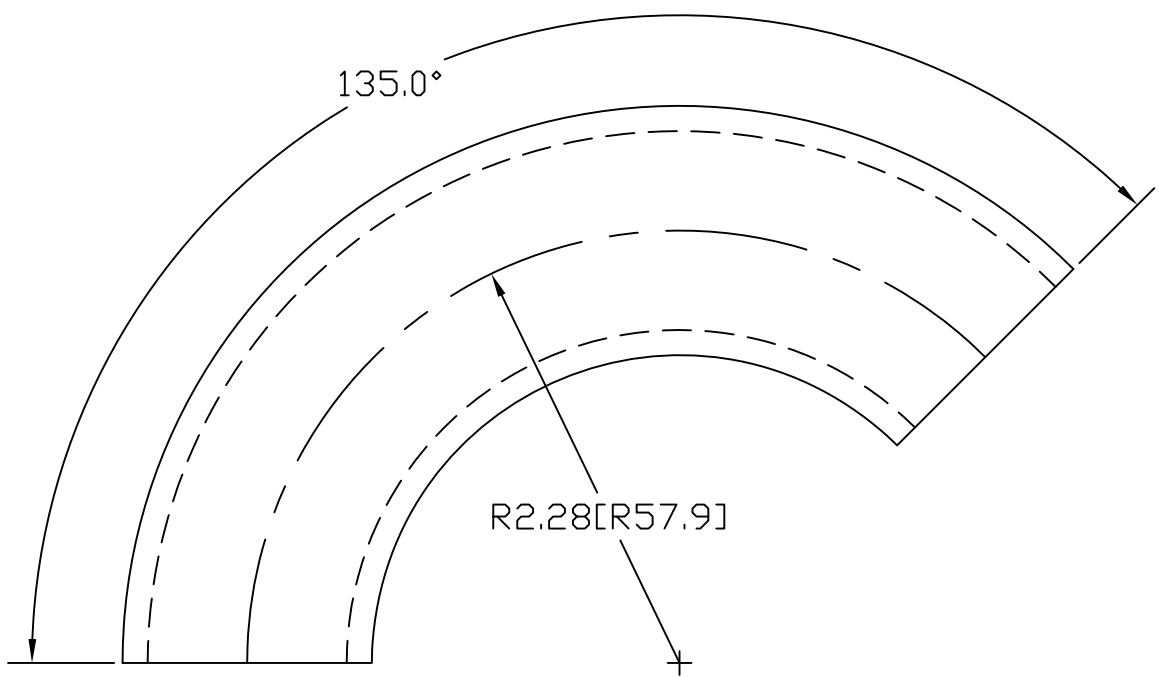

INCHES [MILLIMETERS]

ALTERNATE MATERIAL	PART NUMBER
1" SCH 40 (6063) ALUMINUM PIPE	4525
1" SCH 40 (304) STAINLESS STEEL PIPE	4539

PART NAME		1" PIPE SIZE 135° ELL X 1-5/8" I.R.			
MATERIAL		1" SCH 40 A53 STEEL PIPE			
DATE	8/18/95	 R & B WAGNER, INC.			
DRAWN BY	RJF				
FINISH	MILL	SIZE	WEIGHT	PART NUMBER	REV
		A	.75 LBS	4511	