

REV
SH
4433
DWG NO

REVISIONS			
REV	DESCRIPTION	DATE	APPROVED

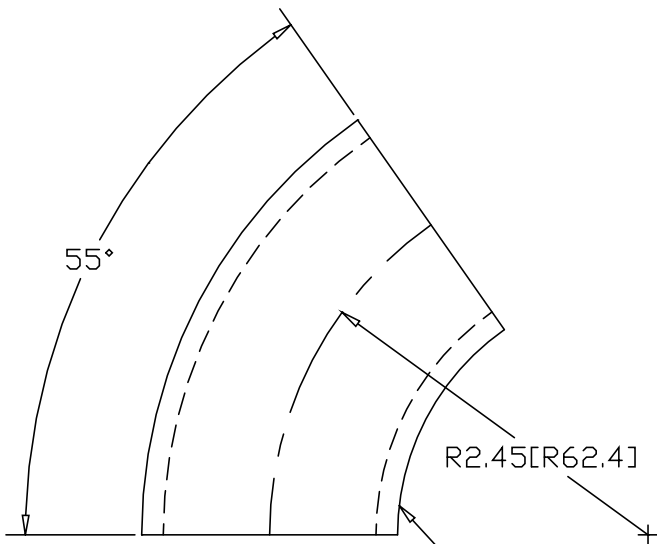

NOTE: UNWELDED SEAM
ALONG INSIDE RADIUS
(STEEL ELLS ONLY)

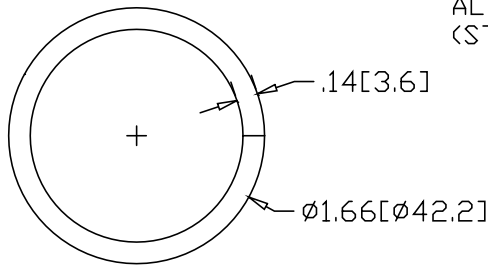

INCHES [MILLIMETERS]

ALTERNATE MATERIAL	PART NUMBER
1-1/4" SCH 40 (6063) ALUMINUM PIPE	4443
1-1/4" SCH 40 (304) STAINLESS STEEL PIPE	4653

PART NAME				1-1/4" PIPE SIZE 55° ELL X 1-5/8" I.R.	
MATERIAL				10 GA. HRP&D STEEL ASTM A569	
DATE	8/18/95			R & B WAGNER, INC.	
DRAWN BY	RJF				
FINISH	MILL	SIZE	A	WEIGHT	.45 LBS
			PART NUMBER	4433	REV