

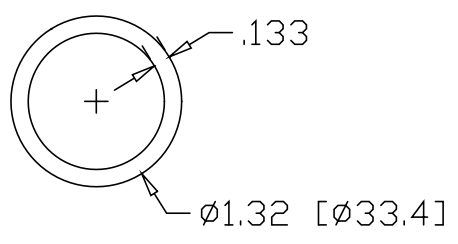

REV
SH
5604
DWG NO

REVISIONS			
REV	DESCRIPTION	DATE	APPROVED

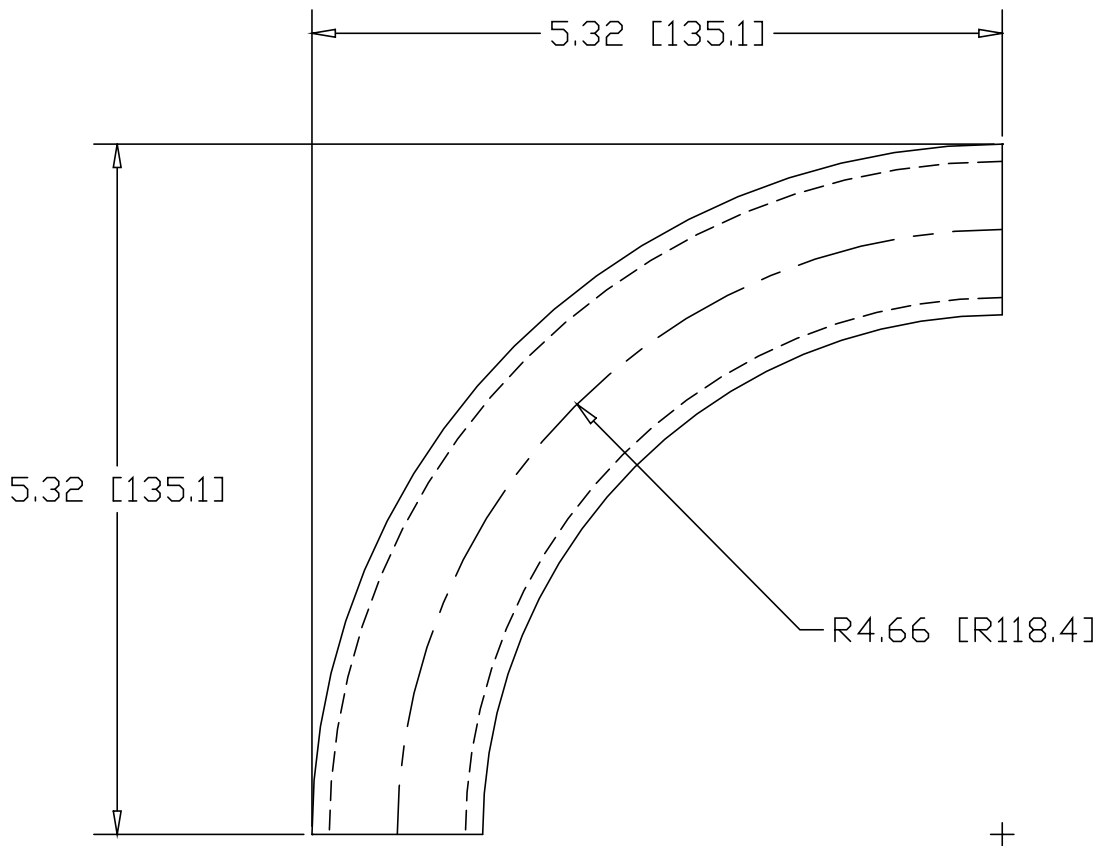

INCHES [MILLIMETERS]

ALTERNATE MATERIAL	PART NUMBER
1" SCH 40 (6063) ALUMINUM PIPE	5614
1" SCH 40 (304) STAINLESS STEEL PIPE	5624

PART NAME		1" PIPE SIZE 90° ELL X 4" I.R.				
MATERIAL		1" SCH 40 A53 STEEL PIPE				
DATE	4/5/96	 R & B WAGNER, INC.				
DRAWN BY	RJF					
FINISH	MILL					
SIZE	A	WEIGHT	1.02 LBS	PART NUMBER	5604	REV