

REV
SH
2071B
DWG NO

REVISIONS			
REV	DESCRIPTION	DATE	APPROVED

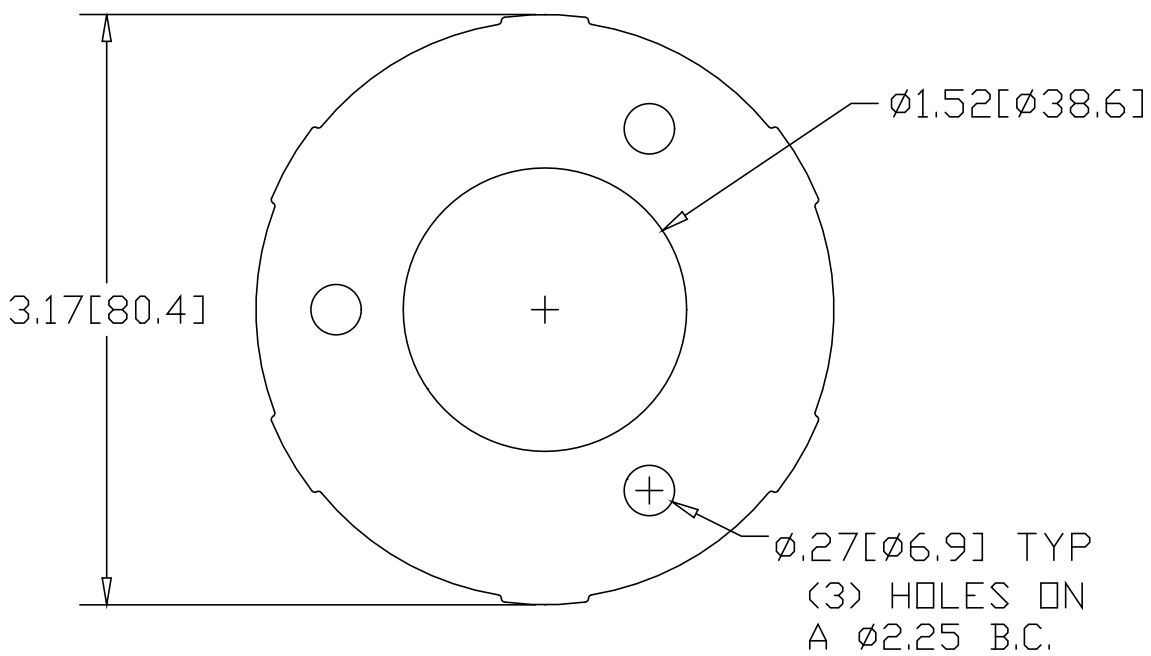

* USE WITH SNAP-COVER
 #2071 IN STEEL
 #2072 IN ALUMINUM
 #2073 IN STAINLESS
 #2074 IN BRASS

INCHES [MILLIMETERS]

ALTERNATE MATERIAL	PART NUMBER
.190 (3003) ALUMINUM ASTM B209	2072B
7 GA. (304) STAINLESS STEEL A240	2073B
.18 (260) BRASS B19,B36	2074B

PART NAME		1.50" OD TUBE SNAP COVER BASE	
MATERIAL		7 GA. HRP&O STEEL ASTM A569	
DATE	8/15/96	 R & B WAGNER, INC.	
DRAWN BY	RJF		
FINISH	MILL	SIZE	A
		WEIGHT	.39 LBS
		PART NUMBER	2071B
		REV	