

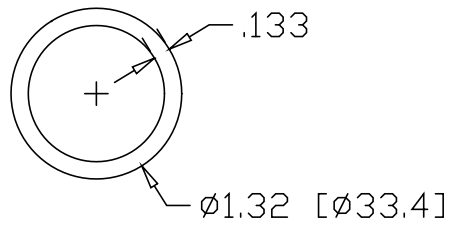

REV
SH
5603
DWG NO

REVISIONS			
REV	DESCRIPTION	DATE	APPROVED

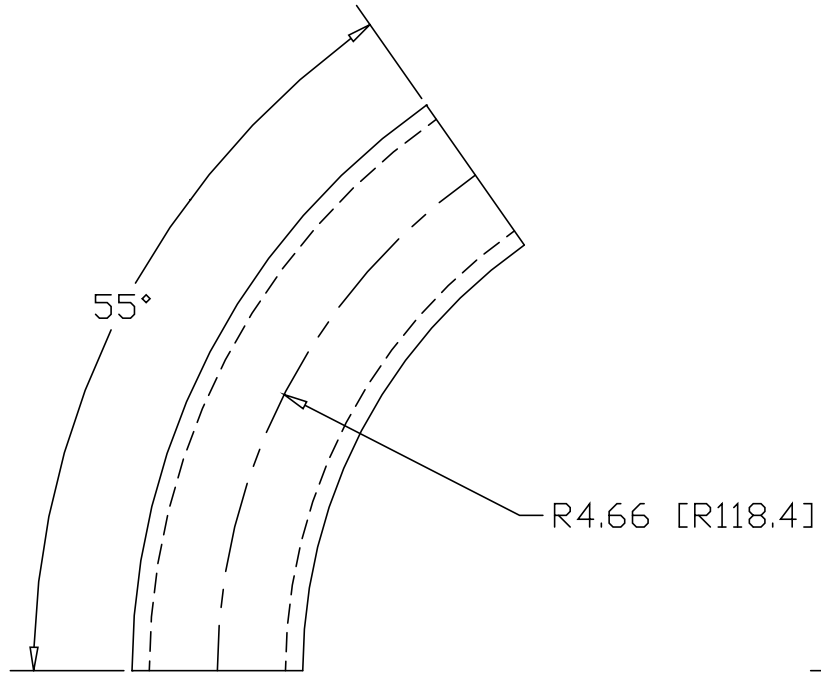

INCHES [MILLIMETERS]

ALTERNATE MATERIAL	PART NUMBER
1" SCH 40 (6063) ALUMINUM PIPE	5613
1" SCH 40 (304) STAINLESS STEEL PIPE	5623

PART NAME		1" PIPE SIZE 55° ELL X 4" I.R.					
MATERIAL		1" SCH 40 A53 STEEL PIPE					
DATE	4/5/96	 R & B WAGNER, INC.					
DRAWN BY	RJF						
FINISH	MILL						
SIZE	A	WEIGHT	.62 LBS	PART NUMBER	5603	REV	