

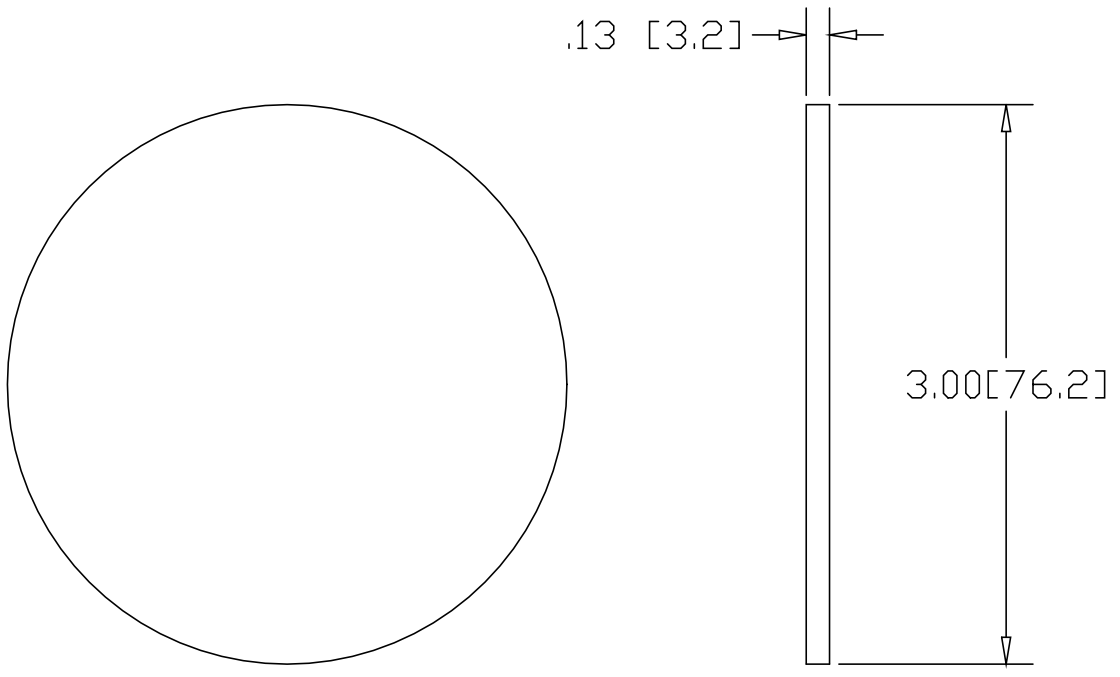

REV  
SH  
D135  
DWG NO

REVISIONS			
REV	DESCRIPTION	DATE	APPROVED



INCHES[MILLIMETERS]

ALTERNATE MATERIAL	PART NUMBER
.125 (3003) ALUMINUM ASTM B209	D136
10 GA. (304) STAINLESS STEEL ASTM A240	D137
.125 (260) BRASS ASTM B19,B36	D138

PART NAME		3.00" OD TUBE SIZE TYPE-D WELD-ON DISK					
MATERIAL		10 GA. HRP&D STEEL ASTM A569					
DATE	11/20/98	 <b>THE WAGNER COMPANIES</b> R & B WAGNER, INC. AND J. G. BRAUN CO.					
DRAWN BY	RJF						
FINISH	MILL						
SIZE	A	WEIGHT	.25 LBS	PART NUMBER	D135	REV	