

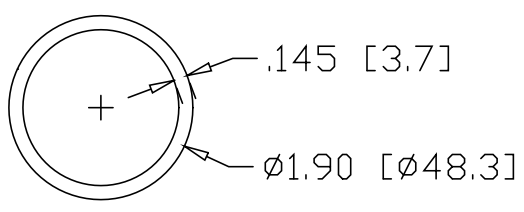

REV  
SH  
5664  
DWG NO

REVISIONS			
REV	DESCRIPTION	DATE	APPROVED

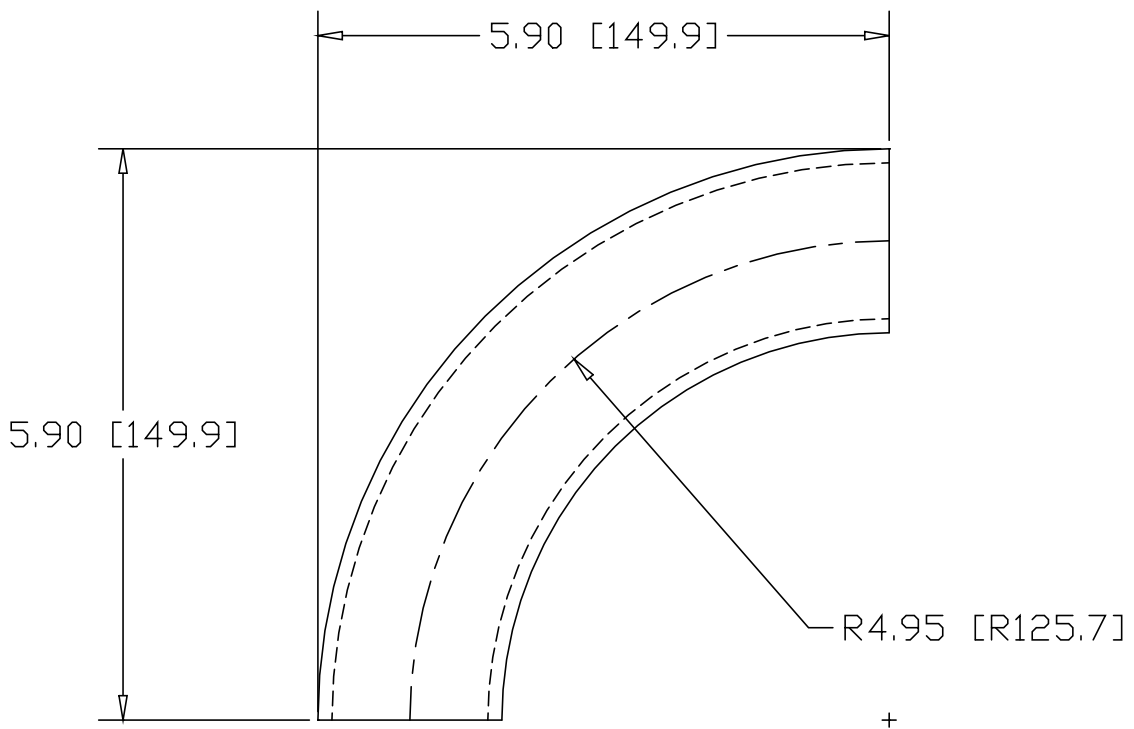

INCHES [MILLIMETERS]

ALTERNATE MATERIAL	PART NUMBER
1-1/2" SCH 40 (6063) ALUMINUM PIPE	5674
1-1/2" SCH 40 (304) STAINLESS STEEL PIPE	5684

PART NAME				1-1/2" PIPE SIZE 90° ELL X 4" I.R.			
MATERIAL				1-1/2" SCH 40 A53 STEEL PIPE			
DATE	4/5/96	 <b>R &amp; B WAGNER, INC.</b>					
DRAWN BY	RJF						
FINISH	MILL						
SIZE	A	WEIGHT	1.76 LBS	PART NUMBER	5664	REV	