

REV
SH
DWG NO B4160

REVISIONS			
REV	DESCRIPTION	DATE	APPROVED

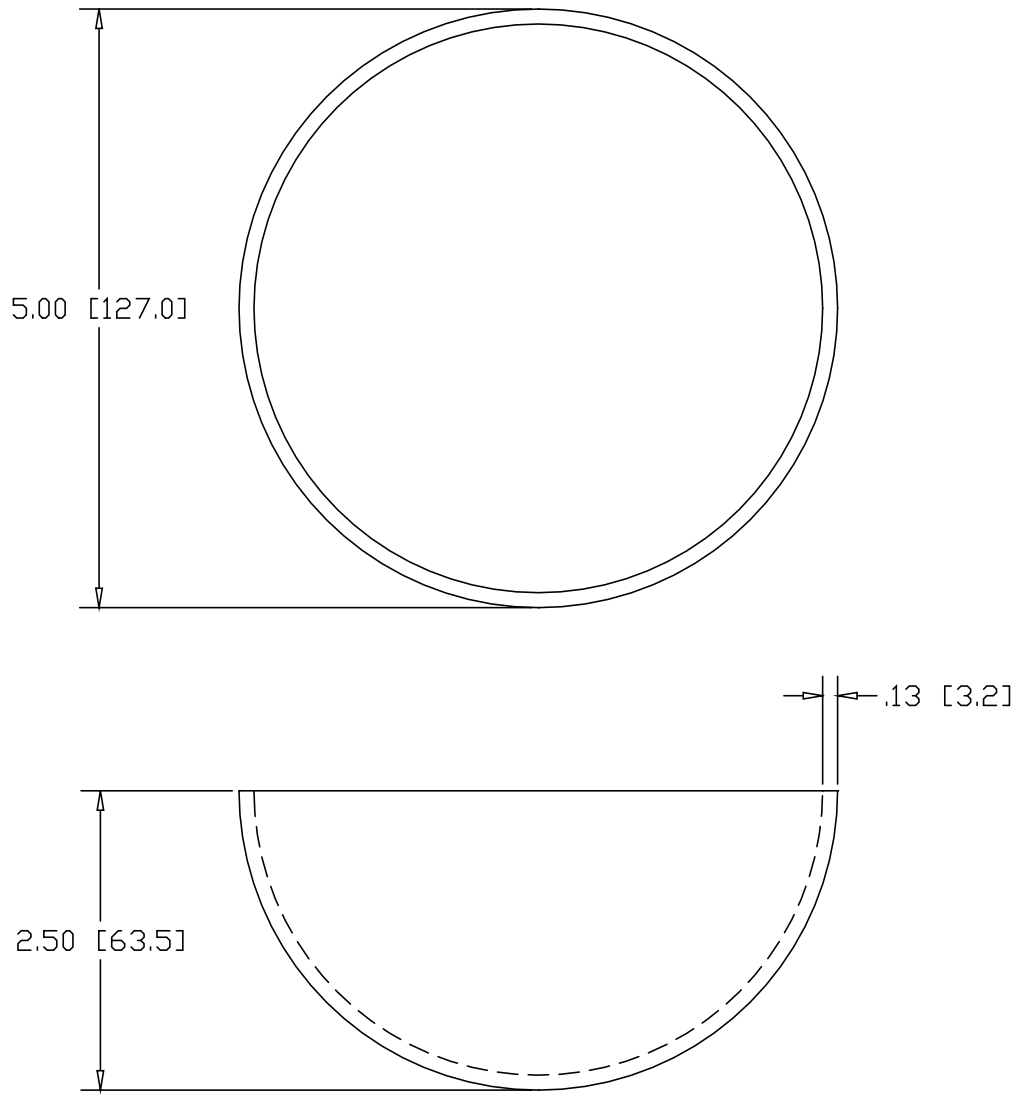

INCHES [MILLIMETERS]

ALTERNATE MATERIAL	PART NUMBER
.125 (3003) ALUMINUM SHEET ASTM B209	B4162
11 GA. (.1200) 304 STAINLESS STEEL A240	B4164
.125 (260) BRASS	B4166
.125 (655) SILICON BRONZE	BSB4160

PART NAME		5.00" HEMISPHERE	
MATERIAL		11 GA. (.1196) HRP&D STEEL SHEET ASTM A569	
DATE	1/4/00		THE WAGNER COMPANIES R & B WAGNER, INC. AND J. G. BRAUN CO.
DRAWN BY	RJF		
FINISH	MILL		
SIZE	A	WEIGHT	1.06 LBS
PART NUMBER		B4160	
REV			