

REV
SH
2536
DWG NO

REVISIONS			
REV	DESCRIPTION	DATE	APPROVED

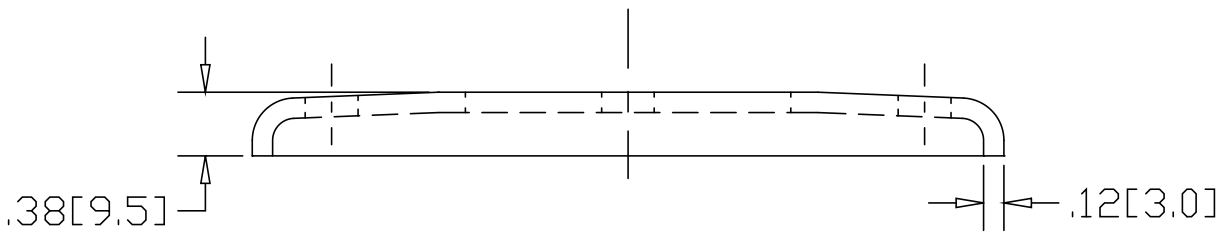
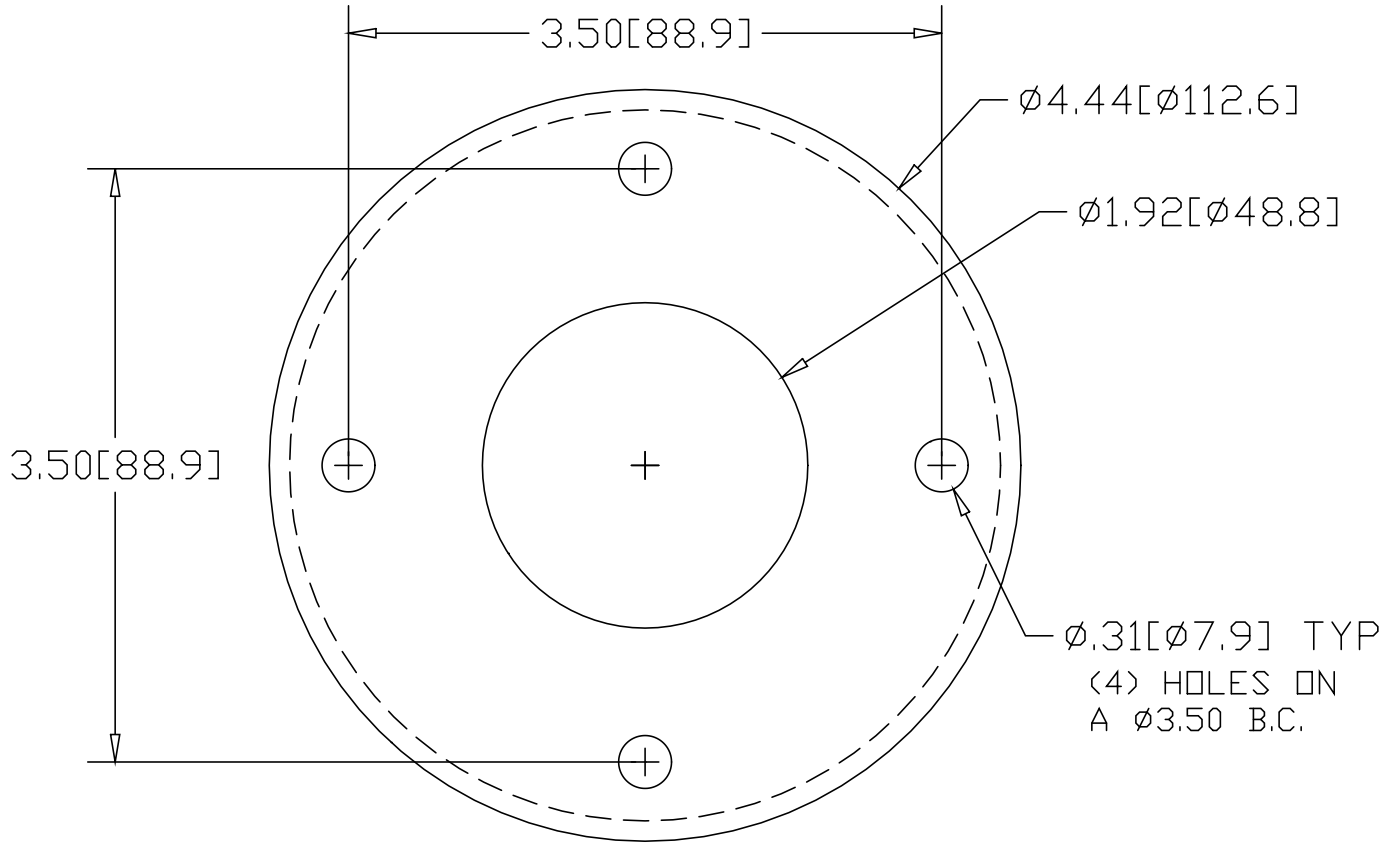

INCHES [MILLIMETERS]

*USE WITH ANCHOR PLATE
#B1440 IN STEEL
#PLB1440 ZINC PLATED STEEL
#B1540 IN STAINLESS

ALTERNATE MATERIAL	PART NUMBER
.125 (3003) ALUMINUM ASTM B209	2576
10 GA. (304) STAINLESS STEEL ASTM A240	2616

PART NAME 1-1/2" PIPE HEAVY FLUSH BASE FLANGE W/(4) HOLES			
MATERIAL 10 GA. HRP&D STEEL ASTM A569			
DATE 9/6/94	 R & B WAGNER, INC.		
DRAWN BY RJF			
FINISH MILL			
SIZE A	WEIGHT .52 LBS	PART NUMBER 2536	REV