

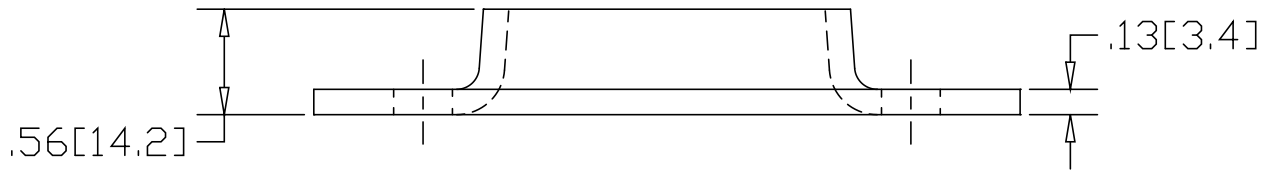

REV
SH
627A
DWG NO

REVISIONS			
REV	DESCRIPTION	DATE	APPROVED

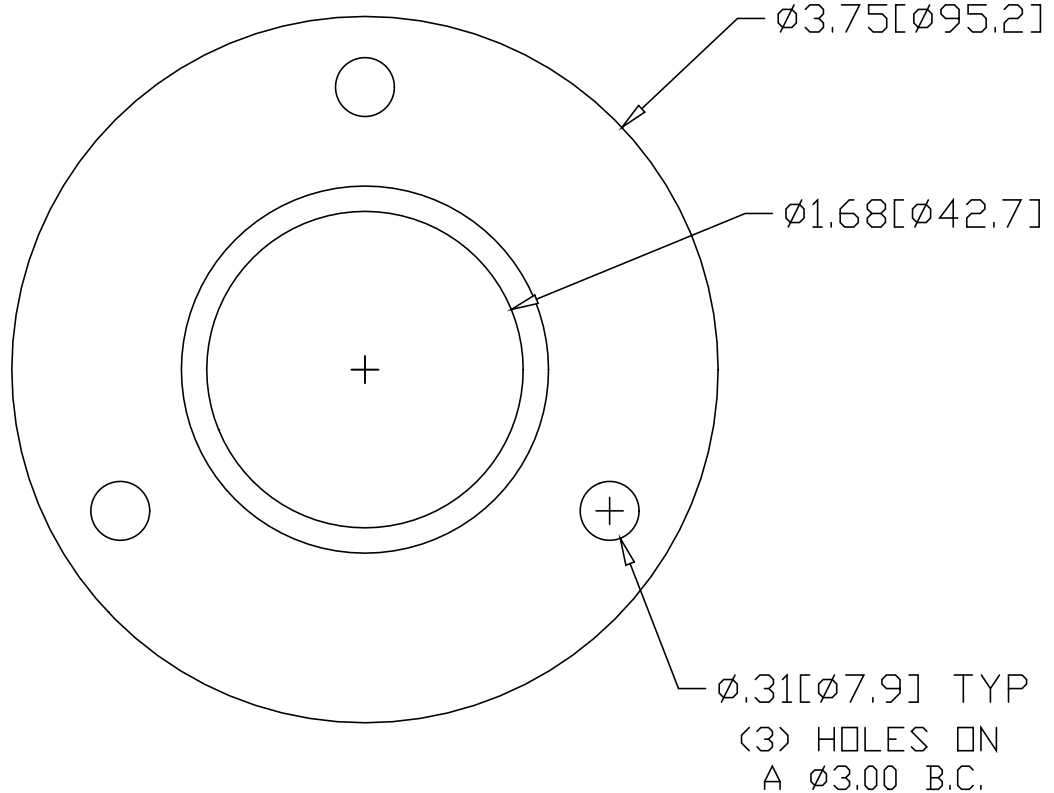

INCHES [MILLIMETERS]

ALTERNATE MATERIAL	PART NUMBER
.125 (3003) ALUMINUM ASTM B209	667A
10 GA. (304) STAINLESS STEEL ASTM A240	707A

PART NAME				1-1/4" FLAT BASE PIPE FLANGE W/(3) HOLES	
MATERIAL				10 GA. HRP&D STEEL ASTM A-569	
DATE	1/7/99			R & B WAGNER, INC.	
DRAWN BY	RJF				
FINISH	MILL	SIZE	A	WEIGHT	.42 lbs
			PART NUMBER	627A	REV