

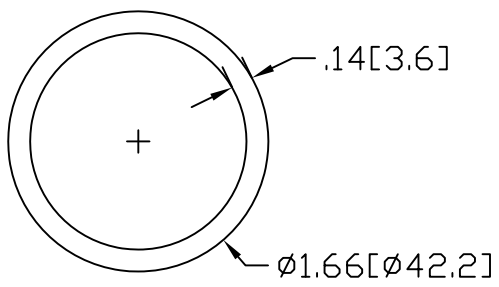

REV
SH
269-4
DWG NO

REVISIONS			
REV	DESCRIPTION	DATE	APPROVED

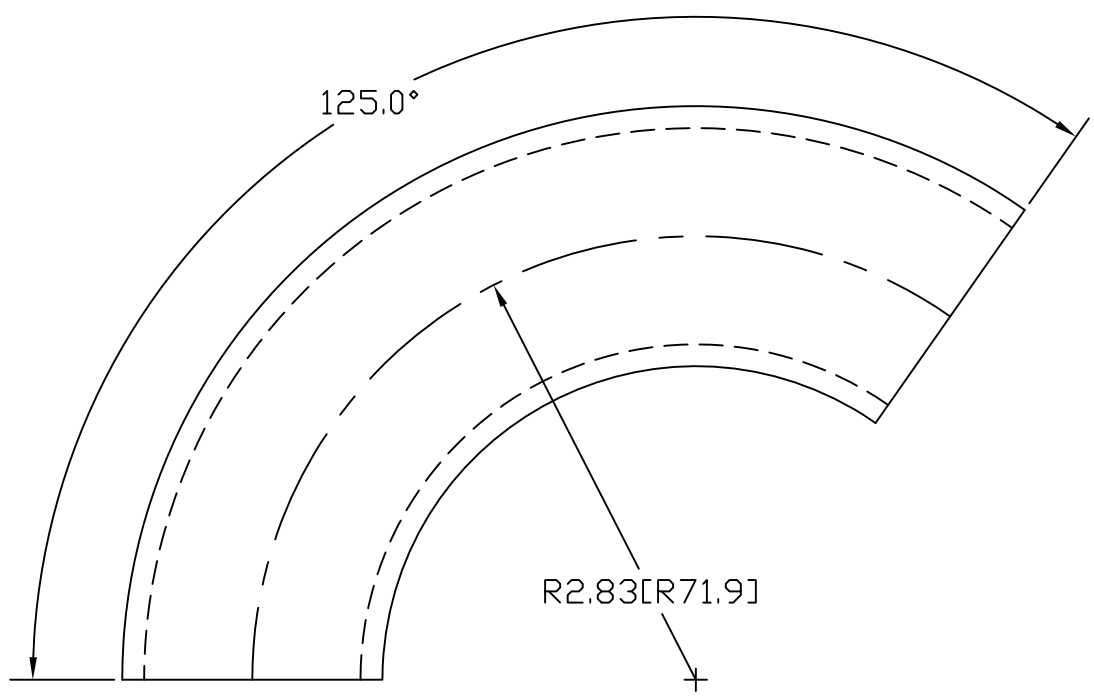

INCHES [MILLIMETERS]

ALTERNATE MATERIAL	PART NUMBER
1-1/4" SCH 40 (6063) ALUMINUM PIPE	293-4

PART NAME		1-1/4" PIPE SIZE 125° ELL X 2" I.R.			
MATERIAL		1-1/4" SCH 40 STEEL PIPE			
DATE	8/24/95	 R & B WAGNER, INC.			
DRAWN BY	RJF				
FINISH	MILL	SIZE	WEIGHT	PART NUMBER	REV
		A	1.22 LBS	269-4	