

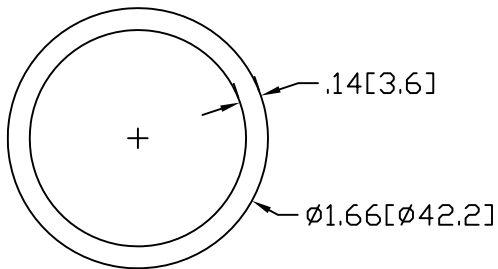

REV
SH
4724
DWG NO

REVISIONS			
REV	DESCRIPTION	DATE	APPROVED

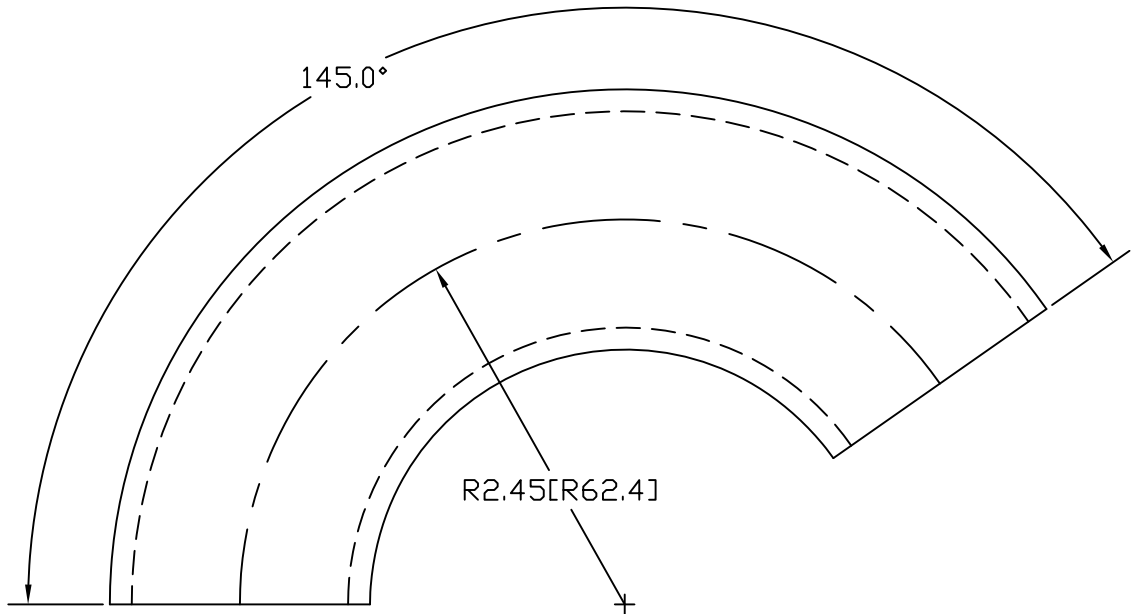

INCHES [MILLIMETERS]

ALTERNATE MATERIAL	PART NUMBER
1-1/4" SCH 40 (6063) ALUMINUM PIPE	4729
1-1/4" SCH 40 (304) STAINLESS STEEL PIPE	4659

PART NAME		1-1/4" PIPE SIZE 145° ELL X 1-5/8" I.R.		
MATERIAL		1-1/4" SCH 40 STEEL PIPE		
DATE	8/18/95	 R & B WAGNER, INC.		
DRAWN BY	RJF			
FINISH	MILL	SIZE	WEIGHT	PART NUMBER
		A	1.06 LBS	4724
				REV