

REV
SH
6960
DWG NO

REVISIONS			
REV	DESCRIPTION	DATE	APPROVED

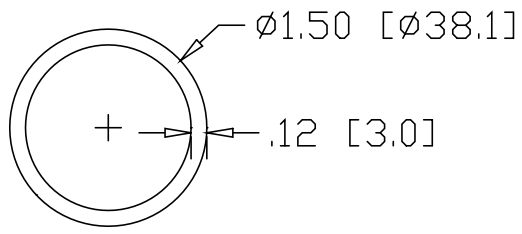
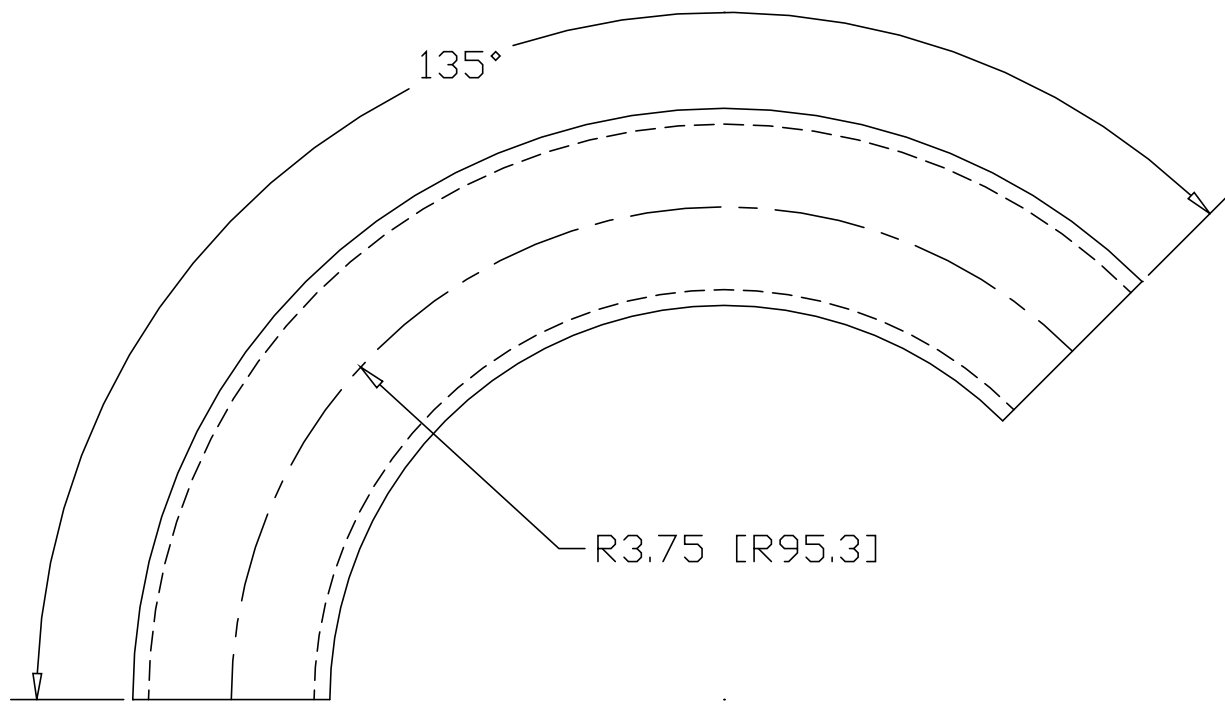

INCHES [MILLIMETERS]

PART NAME		1.50" O.D. TUBE 135° ELL X 3.75" CLR					
MATERIAL		1.50" O.D. X .120W STEEL TUBE					
DATE	9/22/00		THE WAGNER COMPANIES R & B WAGNER, INC. AND J. G. BRAUN CO.				
DRAWN BY	RJF						
FINISH	MILL						
SIZE	A	WEIGHT	1.31 LBS	PART NUMBER	6960	REV	