

REV  
SH  
7188  
DWG NO

REVISIONS			
REV	DESCRIPTION	DATE	APPROVED

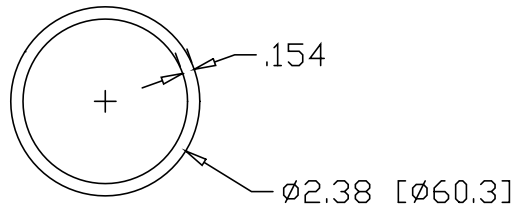
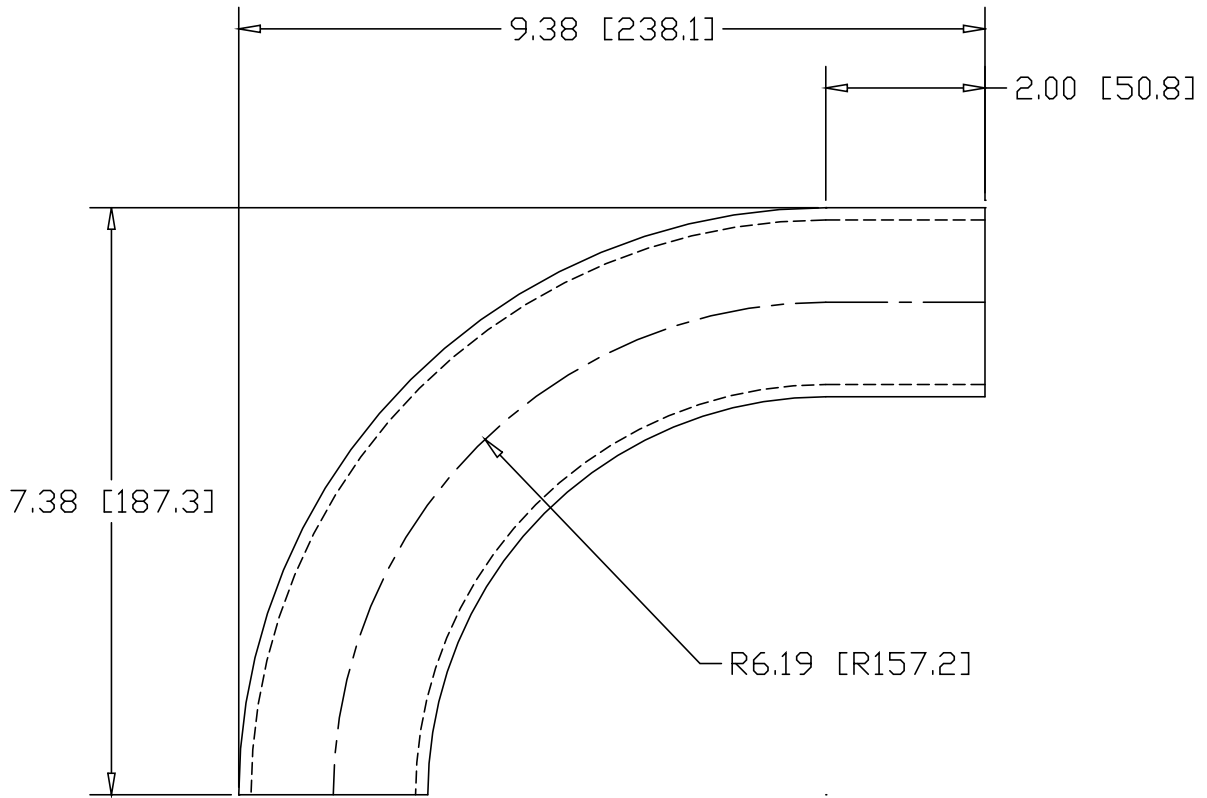

INCHES [MILLIMETERS]

ALTERNATE MATERIAL	PART NUMBER
2" SCH 40 (6063) ALUMINUM PIPE	7208
2" SCH 40 (304) STAINLESS STEEL PIPE	7228

PART NAME 2" PIPE SIZE 90° ELL X 5" I.R. W/ (1) 2" TANGENT			
MATERIAL 2" SCH 40 A53 STEEL PIPE			
DATE 7/02/01			
DRAWN BY JAH			
FINISH MILL			
SIZE A	WEIGHT 3.57 LBS	PART NUMBER 7188	REV